



Brand-name umbrellas & accessories

2024 Catalogue



Make your

SUMMER

even better

Your competent & reliable partner



Outstanding quality, fair prices

The brand "Schneider Schirme" embodies carefully selected materials and an attractive design. These characteristics ensure that our products will always operate flawlessly. Various institutions have consistently attested to this quality over the years.



More than 150 years of experience

Established in 1868, our company is owned and operated in the 5th generation and has always managed to adapt to the needs of the times. This know-how and experience have made us one of the market leaders in Europe.



Annex building adding 6,000 sqm of space to the company headquarters in Mengen - occupied since February of 2022



Eye-catching displays at the POS

With sales displays for sun umbrellas, shade sails, accessories and umbrella stands, we support retailers in their presentation of our products at the point of sale.



Complete line for every need

Whether you need standard, large, restaurant or professional umbrellas, in small or large quantities, single-colour or printed, Schneider Umbrellas is your ideal partner.



Rooted in the region, connected world-wide

Investments in our production and storage facilities in the south of Germany and the expansion of international relations are key contributors to our success and guarantee optimal merchandise supply. The commitment to our home location, quality and customer proximity is as strong as ever.



Effective UV protection

Since responsible protection against UV radiation has been a great concern of ours from the start, all of our umbrellas are always certified in accordance with international standards.

For more than 150 years



Completion of the annex building **2022**



2011 Expansion by high-bay warehouses 1 & 2
+ 2014



Expansion and simultaneous move of production and administration to Oberschring in Mengen **2005**



1995 Representing the family's *fifth* generation, Rolf Guffarth joins the company as its Managing Director

Expansion in Mengen's industrial park **1973**



1969 Release of the first catalogue of garden umbrella products

Garden umbrellas are produced for the first time **1967**

1868 Company founded as a factory for rain umbrellas



SCHNEIDER
Premium



Page 6 - 15



SCHNEIDER
Classics



Page 16 - 51



SCHNEIDER
GREEN STYLE



Page 52 - 53



SCHNEIDER
SUNNY



Page 54 - 59



SCHNEIDER
Shade sails



Page 60 - 65



SCHNEIDER
Accessories

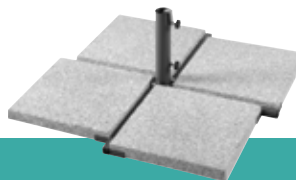

Page 66 - 79



SCHNEIDER
Displays



Page 80 - 81





Premium segment:

Attractive design and ergonomic form, combined with stylish colours, give the Premium segment its own special appearance!



Bermuda

260 x 350 cm
(page 11)



Monaco

300 x 300 cm
(page 13)



Gemini

360 cm Ø
(page 14)

Aquila

200 cm Ø
Art. no. 753-..

250 cm Ø
Art. no. 754-..



Premium top with soft grip



Premium slider with soft grip



Metal tilt mechanism with button



Premium locking knob with soft grip

Canopy:

100 % polyester,
ca. 220 g/m², rot-proof,
water-repellent impregnation,
with structured surface,
with valance, with band trim

Frame:

anthracite powder-coated steel frame,
metal tilt mechanism with button,
slider, locking knob and top feature
a 2-colour "soft-grip" design,
two-part pole 22/25 mm for size 200 cm Ø,
two-part pole 27/30 mm for size 250 cm Ø

Dimensions (cm):

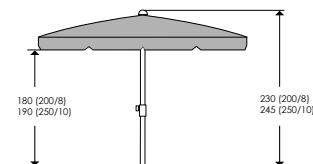

...-02
ecru



...-04
gold yellow



...-05
terracotta



...-07
dark red



...-11
green



...-14
silver grey

ca.
200 cm Ø



ca.
250 cm Ø



Aquila

225 x 120 cm 265 x 150 cm
 Art. no. 755-.. Art. no. 756-..



Canopy:

100 % polyester,
 ca. 220 g/m², rot-proof,
 water-repellent impregnation,
 with structured surface,
 with valance, with band trim

Frame:

anthracite powder-coated steel frame,
 metal tilt mechanism with button,
 slider, locking knob and top feature
 a 2-colour "soft-grip" design,
 two-part pole 27/30 mm
 braces of sturdy fibreglass



Premium top with soft grip



braces of sturdy fibreglass



Metal tilt mechanism with button

Premium locking knob with soft grip

Dimensions (cm):

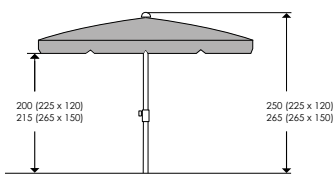

...-02
 ecru



...-04
 gold yellow



...-05
 terracotta



...-07
 dark red



...-11
 green



...-14
 silver grey

ca.
 225 x 120 cm



ca.
 265 x 150 cm



Bermuda

350 cm Ø

Art. no. 733-..



Sturdy umbrella mount



Pivoting umbrella canopy



Handle for opening, inclining and tilting



Solid rotary joint with foot pedal

Canopy:

100 % polyester, ca. 200 g/m², rot-proof, water-repellent impregnation, highly fade-resistant, without valance, with air vent, removable for washing by hand, includes light-proof protective sleeve with zip and rod

Frame:

Adjustable in 3 dimensions:

1. Rotary plate for rotating 360° with foot pedal
2. Tilts up to 50° along the pole
3. Can be tilted on both sides up to 45° along the radial arm (by handle)

silver grey powder-coated aluminium/ steel frame, top joint, cast aluminium handle and crown, ca. 26 x 18 mm braces, one-part pole ca. 55 x 86 mm, includes cross base for 50 x 50 x 5 cm paving slabs (slabs not included)

TIP: For matching accessories, please refer to page 68 - 71



Dimensions (cm) for size 350 cm Ø:

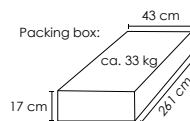
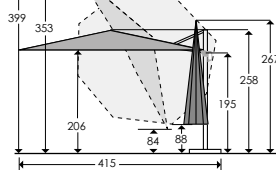

733-02 ecru



733-06 red



733-15 anthracite

ca. 350 cm Ø



Application video



Assembly instructions



Bermuda

260 x 350 cm

Art. no. 734-..



Sturdy umbrella mount



Pivoting umbrella canopy



Handle for opening, inclining and tilting

Solid rotary joint with foot pedal

Canopy:

100 % polyester,
ca. 200 g/m², rot-proof,
water-repellent impregnation,
highly fade-resistant,
without valance, with air vent,
removable for washing by hand,
includes light-proof protective
sleeve with zip and rod

silver grey powder-coated aluminium/
steel frame, top joint,
cast aluminium handle and crown,
ca. 26 x 18 mm braces, one-part pole
ca. 55 x 86 mm, includes cross base for
50 x 50 x 5 cm paving slabs
(slabs not included)

Frame:

Adjustable in 3 dimensions:

1. Rotary plate for rotating 360° with foot pedal
2. Tilts up to 50° along the pole
3. Can be tilted on both sides up to 45° along the radial arm (by handle)

TIP: For matching accessories, please refer to page 68 - 71



Dimensions (cm)
for size 260 x 350 cm:

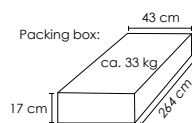
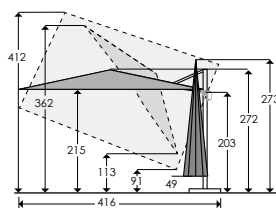

734-02
ecru



734-15
anthracite

ca.
260 x 350 cm



Application video



Assembly instructions



Monaco

350 cm Ø
Art. no. 775-15



Sturdy umbrella frame



Brace joints



Brace ends

Crank

Canopy:

100 % polyester,
ca. 280 g/m², rot-proof,
water-repellent impregnation,
highly fade-resistant,
without valance, with air vent,
removable for washing by hand,
includes protective sleeve with
zip and rod

Frame:

silver grey powder-coated
aluminium/steel,
two-part pole 48 mm Ø,
braces 17 x 25 mm,
crank to open

Dimensions (cm):

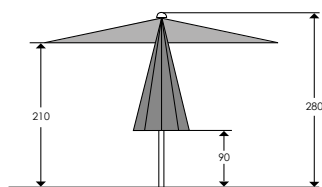

775-15
granite grey

ca.
350 cm Ø



Monaco

300 x 300 cm

Art. no. 776-15



Sturdy umbrella frame



Brace joints



Crank mechanism integrated in handle

Solid rotary joint with foot pedal

Canopy:

100 % polyester, ca. 280 g/m², rot-proof, water-repellent impregnation, highly fade-resistant, without valance, with air vent, removable for washing by hand, includes light-proof protective sleeve with zip and rod

Frame:

silver grey powder-coated aluminium/steel, braces 17 x 25 mm, one-part pole 55 x 86 mm, rotary plate for rotating 360° with foot pedal, tilting, includes cross base for 50 x 50 x 5 cm paving slabs (slabs not included)

TIP: For matching accessories, please refer to page 68 - 71



Dimensions (cm):

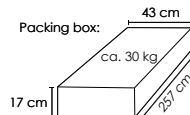
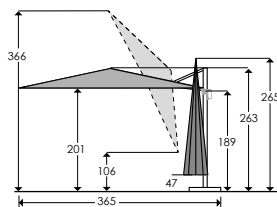

776-15
granite grey

ca.
300 x 300 cm



Application video



Assembly instructions



Gemini

360 cm Ø

Art. no. 644-..



Finishing top



Large air vent (air outlet)

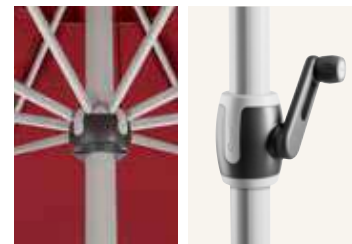

Sturdy slider

Premium crank

Canopy:

100 % polyester, ca. 220 g/m², rot-proof, water-repellent impregnation, without valance, with large air vent, with structured surface, removable for washing by hand

Frame:

silver grey powder-coated aluminium frame, with fine line structure, two-part pole 48 mm Ø, braces 12 x 18 mm, crank, all components in two-colour design

Dimensions (cm):

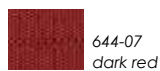
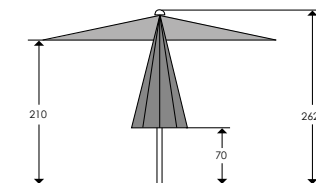

ca.
360 cm Ø



Premium protective sleeves



PREMIUM protective sleeves

High-quality protective umbrella sleeves for your PREMIUM umbrellas. Made of durable, waterproof and light-proof special polyester fabric. The drawstring features a stopper for closing the protective sleeve at the bottom to prevent insects and mice from building nests (except 321-00).





The sizes for 300 cm Ø and larger also feature a zip and telescoping rod for convenient covering of the closed umbrella, without having to remove it from the umbrella stand.

Sizes 400 cm Ø and larger also come with an air vent for improved air circulation.

Packaged in a sturdy zip bag with a carrying strap, which can also be used for storage.

Packaging unit: 6 items



145 x 20/25 cm	321-00	for umbrellas up to 200 cm Ø and 225 x 120 cm	
183 x 25/35 cm	322-00	for umbrellas up to 300 cm Ø, with zip and rod	
250 x 27/45 cm	323-00	for umbrellas up to 400 cm Ø and 300 x 300 cm, with zip, rod and air vent	
240 x 57 cm	324-00	for hanging umbrellas up to 400 cm Ø and 300 x 300 cm and 350 x 260 cm, with zip, rod and air vent	





NEW in the Classics segment:

Schneider umbrellas fulfil stringent requirements at reasonable prices. Tested materials and standardised manufacturing processes guarantee consistent quality – and the customer is grateful for that!



Rhodos Twist Loft

300 x 300 cm
(page 46)

Locarno

150 cm Ø 200 cm Ø 220 cm Ø 180 x 120 cm

Art. no. 715-.. Art. no. 716-.. Art. no. 717-.. Art. no. 718-..

Ball top

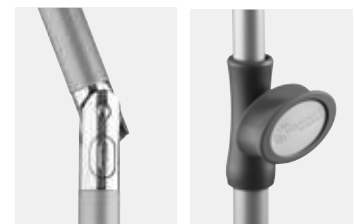
Large slider with button

Metal tilt mechanism with button

Locking knob
Canopy:

 100 % polyester,
 ca. 160 g/m², rot-proof,
 water-repellent impregnation,
 with band trim,
 150 cm Ø, 200 cm Ø,
 180 x 120 cm with valance,
 220 cm Ø without valance

Frame:

 silver grey powder-coated steel frame,
 all plastic parts anthracite grey,
 large slider with button,
 locking knob, ball top,
 metal tilt mechanism with button,
 two-part pole, 22/25 mm Ø

CLASSICS

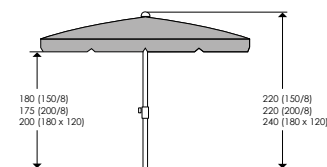
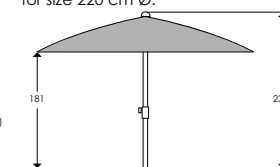

Dimensions (cm) with valance:

 Dimensions (cm) without valance
 for size 220 cm Ø:

...-02 ecru	...-74 citrus	...-75 mandarin	...-77 red	...-79 royal blue	...-78 apple green	...-15 anthracite
----------------	------------------	--------------------	---------------	----------------------	-----------------------	----------------------

ca. 150 cm Ø	715-02 	715-74 	715-75 	715-77 	715-79 	715-78 	715-15
ca. 200 cm Ø	716-02 	716-74 	716-75 	716-77 	716-79 	716-78 	716-15
ca. 220 cm Ø	717-02 	-	-	717-77 	-	717-78 	717-15
ca. 180 x 120 cm	718-02 	718-74 	718-75 	718-77 	718-79 	718-78 	718-15

Ibiza

200 cm Ø 240 cm Ø 180 x 120 cm
 Art. no. 680-.. Art. no. 681-.. Art. no. 682-..



Canopy:

100 % polyester,
 ca. 150 g/m², rot-proof,
 water-repellent impregnation,
 with valance,
 with band trim

Frame:

white powder-coated steel frame,
 two-part pole 22/25 mm Ø,
 metal tilt mechanism,
 lower pole with locking knob

Packaging unit: 4 items per colour

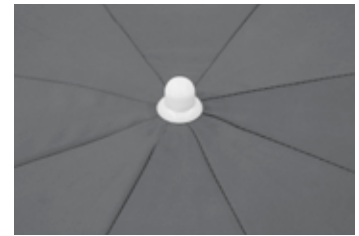

Top



Slider with button



Slider with button

Lower pole with locking knob



Dimensions (cm):

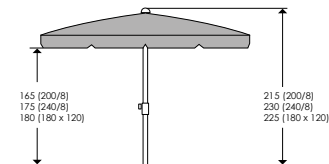

...-02 ecru	...-04 gold yellow	...-05 terracotta	...-09 blue	...-15 anthracite
680-02	680-04	680-05	680-09	680-15
ca. 200 cm Ø				
681-02	681-04	681-05	681-09	681-15
ca. 240 cm Ø				
682-02	682-04	682-05	682-09	682-15
ca. 180 x 120 cm				

Bilbao

220 cm Ø 210 x 130 cm

Art. no. 620-.. Art. no. 621-..



By "continued turning" of the crank the umbrella tilts to provide optimal shade



Frame anthracite grey powder-coated



Automatic tilt mechanism



Crank

Canopy:

100 % polyester, ca. 180 g/m², rot-proof, water-repellent impregnation, without valance, with air vent, removable for washing by hand

Frame:

anthracite grey powder-coated steel frame with automatic tilt mechanism, two-part pole ca. 38 mm Ø, braces ca. 12 x 18 mm, crank to open

CLASSICS



Dimensions (cm) for size 220 cm Ø:

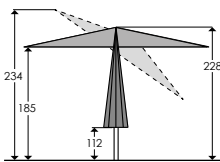

Dimensions (cm) for size 210 x 130 cm:

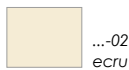
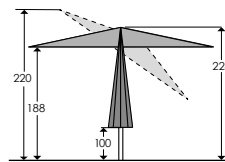

ca. 220 cm Ø



ca. 210 x 130 cm



Harlem

270 cm Ø

Art. no. 640-..



Frame anthracite
grey powder-coated



Metal tilt mechanism



Crank

Canopy:

100 % polyester,
ca. 180 g/m², rot-proof,
water-repellent impregnation,
without valance, with air vent,
removable for washing by hand

Frame:

anthracite grey powder-coated steel
frame, crank, metal tilt mechanism,
two-part pole 38 mm Ø, ball top



Dimensions (cm):

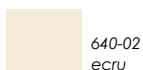
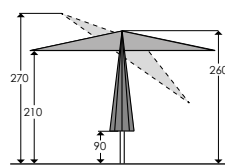

640-02
ecru



640-75
mandarin



640-77
red

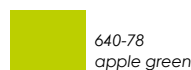

640-78
apple green



640-14
silver grey

ca.
270 cm Ø



Orlando

270 cm Ø

Art. no. 783-..



By "continued turning" of the crank the umbrella tilts to provide optimal shade



Automatic tilt mechanism...



...with convenient crank



Crank

Canopy:

100 % polyester,
 ca. 180 g/m², rot-proof,
 water-repellent impregnation,
 with valance, with air vent,
 removable for washing by hand

Frame:

anthracite grey powder-coated
 aluminium/steel frame with
 automatic tilt mechanism,
 easy to operate by crank,
 crank housing in attractive design,
 two-part pole 38 mm Ø, ball top

Dimensions (cm):

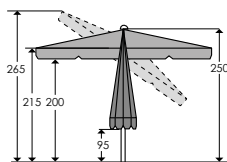

AS/NZS4399

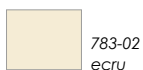
 ca.
 270 cm Ø

Blacklight

270 cm Ø
Art. no. 790-15

LED light strips in the braces



Also as a hanging umbrella
(see page 49)



Solar top



Brace joints and LED light strip



Sturdy metal tilt mechanism



Crank and switch

Canopy:

100 % polyester,
ca. 180 g/m², rot-proof,
water-repellent impregnation,
without valance, with air vent,
removable for washing by hand

Frame:

anthracite grey powder-coated
aluminium aluminium frame, crank,
metal tilt mechanism,
two-part pole 38 mm Ø,
LED light strips in the braces,
3 standard AA batteries in solar top,
separate switch on crank housing,
deep discharge protection,
battery charge lasts ca. 6 hours



Dimensions (cm):

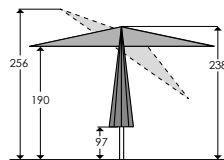

ca.
270 cm Ø



Venedig

270 cm Ø

Art. no. 683-..



Round braces and ...



... black plastic parts ...



... provide for an elegant structure



Crank

Canopy:

100 % polyester,
 ca. 180 g/m², rot-proof,
 water-repellent impregnation,
 without valance, with air vent,
 removable for washing by hand

Frame:

silver grey powder-coated aluminium
 frame, round braces with 16 mm Ø,
 crank, metal tilt mechanism,
 two-part pole 38 mm Ø

Also
 available
 with recycled
 canopy
 (see page 53)

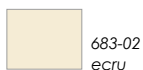
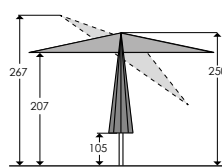

Dimensions (cm):

 ca.
 270 cm Ø

Sevilla

270 cm Ø 240 x 140 cm

Art. no. 664-.. Art. no. 667-..



Rods



Sturdy metal tilt mechanism



Locking knob

Canopy:

100 % polyester,
ca. 180 g/m², rot-proof,
water-repellent impregnation,
without valance, with air vent,
removable for washing by hand

Frame:

anthracite grey powder-coated
steel frame with push-up opening,
braces ca. 12 x 18 mm, metal tilt
mechanism,
height-adjustable up to 60 cm,
two-part pole,
upper pole ca. 38 mm Ø,
lower pole ca. 34 mm Ø



Dimensions (cm)
for size 270 cm Ø:

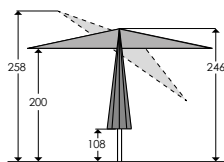

Dimensions (cm)
for size 240 x 140 cm:

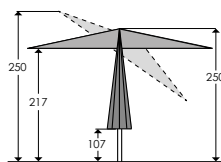

...-02
ecru



...-77
red



...-14
silver grey

ca.
270 cm Ø



664-02

4 000570 664028



664-77

4 000570 664776



664-14

4 000570 664141

ca.
240 x 140 cm



667-02

4 000570 667029



667-77

4 000570 667777



667-14

4 000570 667142

Tunis

270 x 150 cm

Art. no. 742-..

**Easy-tilt
function**

 By "continued turning"
of the crank the umbrella tilts
to provide optimal shade

Brace joints

Frame anthracite grey power-coated

**Automatic tilt
mechanism**
Crank
Canopy:

 100 % polyester,
ca. 180 g/m², rot-proof,
water-repellent impregnation,
highly fade-resistant,
without valance, with air vent,
removable for washing by hand

Frame:

 anthracite grey powder-coated
steel frame,
two-part pole 38 mm Ø,
crank to open,
automatic tilt mechanism

CLASSICS

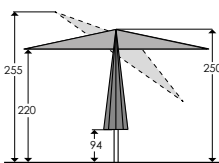

Dimensions (cm):

 ca.
270 x 150 cm

Porto

300 x 200 cm

Art. no. 643-..

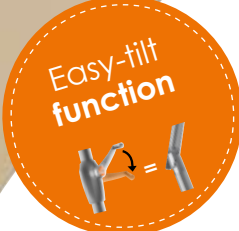

By "continued turning" of the crank the umbrella tilts to provide optimal shade



Brace joints



Frame silver-grey powder-coated



Automatic tilt mechanism

Crank

Canopy:

100 % polyester,
ca. 180 g/m², rot-proof,
water-repellent impregnation,
without valance, with air vent,
removable for washing by hand

Frame:

silver grey powder-coated steel frame,
two-part pole 38 mm Ø,
ca. 12 x 18 mm braces,
crank to open,
automatic tilt mechanism



Dimensions (cm):

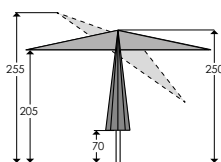

ca.
300 x 200 cm

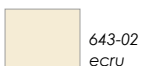

643-02
ecru



643-77
red



643-15
anthracite



Oslo

300 x 200 cm

Art. no. 752-..



Frame: white powder-coated

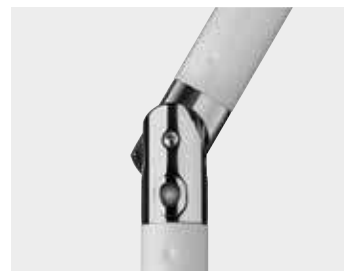

Slider with button



Crank

Canopy:

100 % polyester,
ca. 180 g/m², rot-proof,
water-repellent impregnation,
with valance, with air vent,
band trim,
removable for washing by hand

Frame:

white powder-coated steel frame,
crank, metal tilt mechanism,
two-part pole 38 mm Ø

CLASSICS



Dimensions (cm):

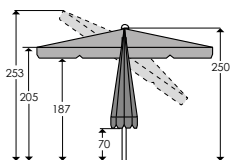

ca.
300 x 200 cm



Rooftop

350 cm Ø

Art. no. 677-..



Canopy:

100 % polyester,
ca. 220 g/m², rot-proof,
water-repellent impregnation,
without valance,
with large air vent,
removable for washing by hand,
each segment fastened
individually along the entire
length of the brace for an
optimum connection with the
umbrella frame,
includes light-proof protective
sleeve with zip and rod

Frame:

silver grey powder-coated aluminium
frame, two-part pole 55 mm Ø,
braces ca. 30 x 20 mm, crank to open,
includes cross base for
8 paving slabs 40 x 40 x 5 cm
(slabs not included)



Large air vent



Fastening along the entire length
of the brace



Sturdy aluminium frame



Dimensions (cm):

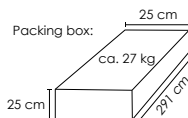
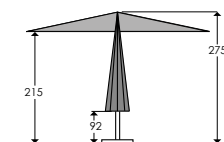

**Sturdy
umbrella**
for
balconies and
roof terraces
and
susceptible
to wind

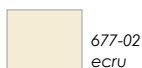
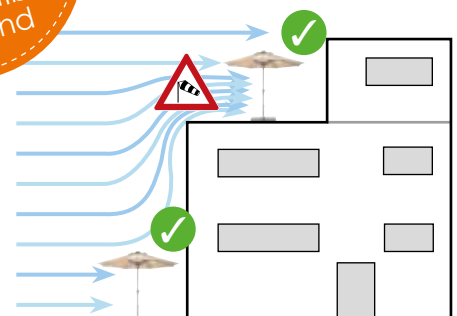

ca.
350 cm Ø



Cordoba

270 cm Ø 230 x 150 cm

Art. no. 689-.. Art. no. 688-..



Steel frame with wood look



Slider with button



Crank

Canopy:

100 % polyester,
ca. 180 g/m², rot-proof,
water-repellent impregnation,
without valance, with air vent,
removable for washing by hand

Frame:

powder-coated steel frame with
wood look, two-part pole 38 mm Ø,
ca. 12 x 18 mm braces,
crank to open, metal tilt mechanism

CLASSICS



Dimensions (cm)
for size 270 cm Ø:

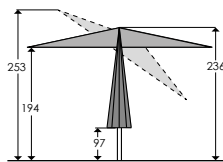

Dimensions (cm)
for size 230 x 150 cm:

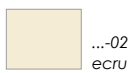
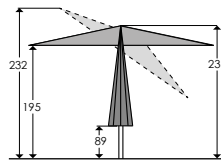

...-02
ecru



...-15
anthracite

ca.
270 cm Ø



ca.
230 x 150 cm



Malaga

300 cm Ø 300 x 200 cm
 Art. no. 614-... Art. no. 615-...

Aluminium
 frame in
 wood look



Canopy:

100 % polyester,
 ca. 180 g/m², rot-proof,
 water-repellent impregnation,
 without valance, with air vent,
 removable for washing by hand

Frame:

powder-coated aluminium/steel
 frame in wood look,
 two-part pole 48 mm Ø,
 plug-in connection,
 all plastic parts in wood look,
 sturdy double cable mechanism,
 size 300 x 200 cm with tilt mechanism



Top



Braces and pole in wood look



Slider in wood look



Tilt mechanism
 (only with 300 x 200 cm)



Dimensions (cm)
 for size 300 cm Ø:

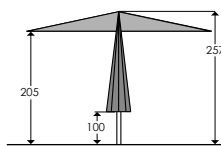

Dimensions (cm)
 for size 300 x 200 cm:

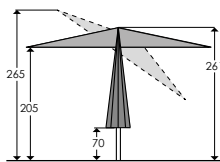

...-02
 ecru

614-02



ca.
 300 cm Ø



...-15
 anthracite

614-15



...-85
 "Forest"

614-85



615-02



ca.
 300 x 200 cm

615-15



Adria

300 cm Ø 350 cm Ø
 Art. no. 684-.. Art. no. 685-..

Elegant market umbrella with
 colour-contrasting canopy seams!



Air vent



Contrasting canopy seams



Metal tilt mechanism for size 300 cm Ø

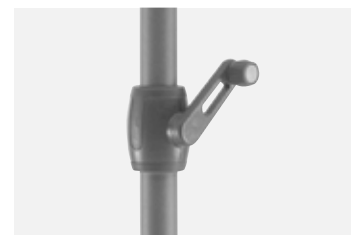

Crank

Canopy:

100 % polyester,
 ca. 200 g/m², rot-proof,
 water-repellent impregnation,
 without valance, with air vent,
 colour-contrasting canopy
 seams to match frame colour,
 removable for washing by hand

Frame:

anthracite grey powder-coated
 aluminium/steel frame,
 crank, two-part pole 48 mm Ø,
 size 300 cm
 additionally with sturdy metal
 tilt mechanism

CLASSICS



Dimensions (cm)
 for size 300 cm Ø:

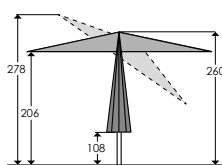

Dimensions (cm)
 for size 350 cm Ø:

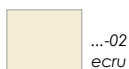
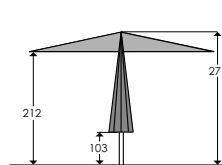

Korsika

320 cm Ø

Art. no. 711-..

Ideal for wicker garden furniture



Air vent



Frame anthracite grey powder-coated



Sturdy crank

Canopy:

100 % polyester
in attractive web look,
ca. 220 g/m², rot-proof,
water-repellent impregnation,
without valance, with air vent,
removable for washing by hand

Frame:

anthracite grey powder-coated
aluminium/steel-coated, crank,
two-part pole 48 mm Ø



AS/NZS4399

Dimensions (cm):

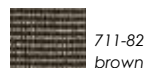
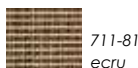
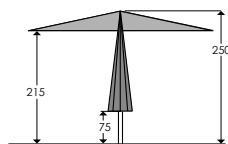

ca.
320 cm Ø



Jumbo

300 cm Ø

400 cm Ø

Art. no. 108-..

Art. no. 110-..



Suitable for
restaurants



Canopy:

100 % high-quality brand-name polyester, ca. 260 g/m², highly tear-resistant and rot-proof, highly fade-resistant acc. to DIN EN ISO 105-B02, highly water- and dust-repellent impregnation and acrylate coating up to 1,000 mm water column, without air vent, with valance, band trim, removable for washing by hand

Frame:

powder-coated aluminium frame, anodised braces, cable mechanism with automatic locking, two-part pole 55 mm Ø, braces ca. 20 x 30 mm, can be replaced singly without tools thanks to new quick-change system



CLASSICS



Ground sleeve
for 55 mm tube,
anodised aluminium

Art. no. 838-00



4 000570 838008

Premium protective sleeve
of durable,
waterproof and light-proof
special polyester fabric,
with zip and rod

Art. no. 816-41



4 000570 816410



Concrete stand ca. 55 kg
for 55 mm tube,
with carrying handles

Art. no. 814-00



4 000570 814003



Cross base
hot galvanised, extra heavy
for paving slabs
50 x 50 x 5 cm, for 55 mm Ø tube
(slabs not included)

Art. no. 839-00



4 000570 839006

ACCESSORIES

Quadro

300 x 300 cm

Art. no. 111-..



Aluminium frame, cable mechanism, automatic locking handle system



Standing seams with band trim for maximum waterproofness

















Easy replacement of braces



Sturdy metal joints

COLOURS

Jumbo and Quadro are available in 14 colours:

 ...-01 white	 ...-02 ecru	 ...-16 sand	 ...-03 yellow	 ...-04 golden yellow
 ...-25 orange	 ...-06 red	 ...-08 bordeaux	 ...-79 royal blue	 ...-09 blue
 ...-11 green	 ...-64 dark green	 ...-15 anthracite	 ...-29 black	

Dimensions (cm) for size 300 cm Ø:

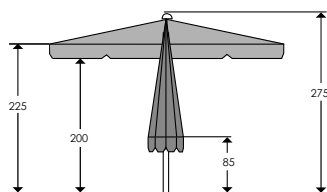

Dimensions (cm) for size 400 cm Ø:

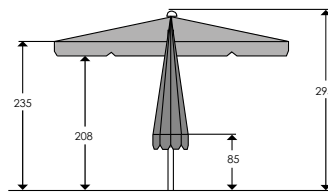

Dimensions (cm) for size 300 x 300 cm:

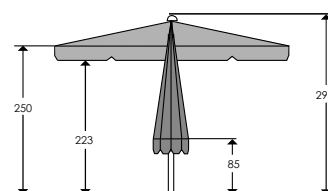

Salerno

300 x 150 cm

Art. no. 746-..



Closes in tight spaces



Powder-coated steel frame



Crank to open

Slider with button

Canopy:

 100 % polyester, ca. 180 g/m²,
 rot-proof, water-repellent
 impregnation, without valance,
 removable for washing by hand,
 includes grey polyester
 protective sleeve with zip
 and rod

Frame:

 anthracite grey powder-coated
 steel frame, crank to open,
 metal tilt mechanism,
 two-part pole 38 mm Ø

CLASSICS

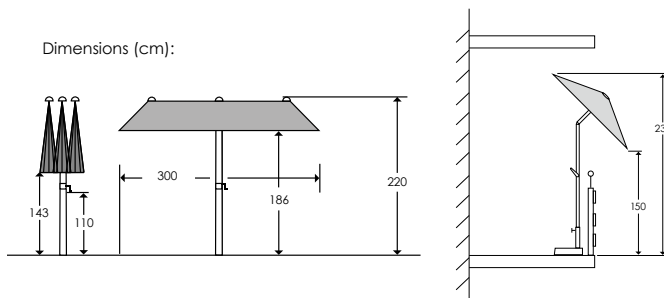

Dimensions (cm):

 ca.
 300 x 150 cm



Opens, closes
and tilts even in
tight spaces, for
example between
a balcony rail and
the storey above!



Salerno mezza

150 x 150 cm

Art. no. 747-..



Ideal balcony umbrella with *two* tilt mechanisms

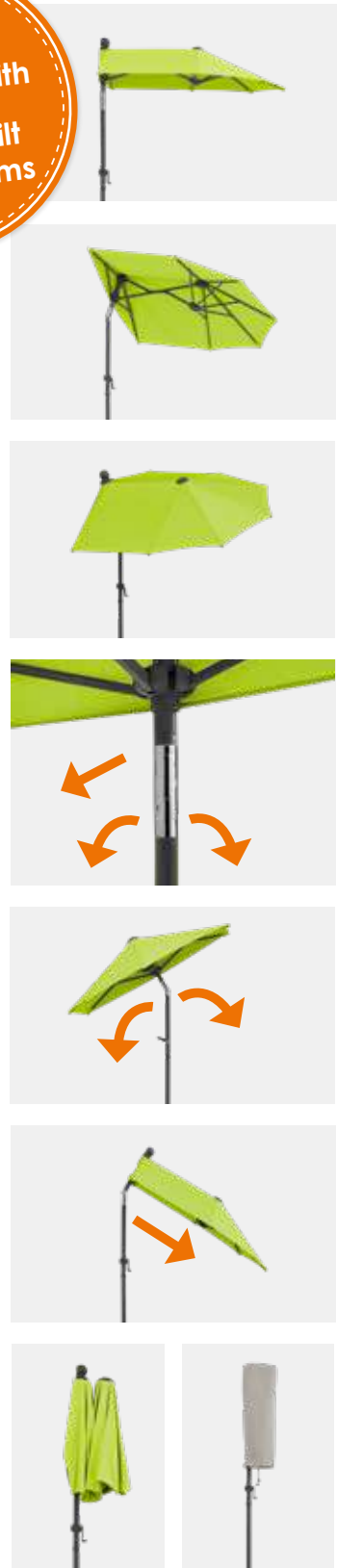

CLASSICS

Canopy:

100 % polyester, ca. 180 g/m², rot-proof, water-repellent impregnation, without valance, removable for washing by hand, includes grey polyester protective sleeve with zip and rod

Frame:

anthracite grey powder-coated steel frame, crank to open, two metal tilt mechanisms (tilt directions offset by 90°), two-part pole 38 mm Ø



Dimensions (cm):

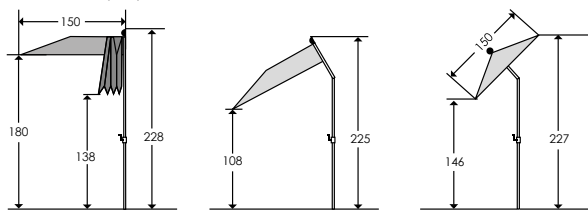

ca. 150 x 150 cm



Novara

190 x 140 cm

Art. no. 758-..



Designed for flexibility:
Rotates and tilts in all directions, slides to the side and is height adjustable!

Canopy:

100 % polyester, ca. 180 g/m², rot-proof, water-repellent impregnation, without valance, removable for washing by hand, includes polyester protective sleeve

Frame:

silver grey powder-coated aluminium/steel frame, two-part pole 32 mm Ø, rotates and tilts in all directions, adjustable up to 20 cm sideways and 69 cm in height



Slider for opening the canopy



Central adjustment



Locking knob with height adjustment



Dimensions (cm):

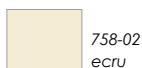
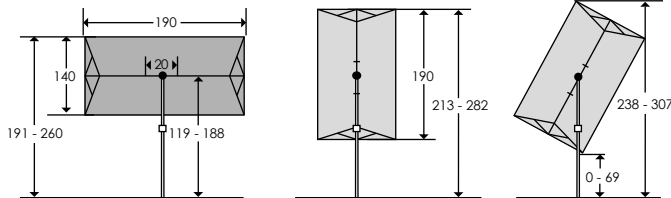

758-02
ecru



758-14
silver grey



758-15
anthracite

ca.
190 x 140 cm



Rhodos Junior

300 cm Ø 230 x 230 cm 270 x 270 cm

Art. no. 760-.. Art. no. 759-.. Art. no. 786-..



Brace joints



Crank mechanism integrated in handle



Solid rotary joint with foot pedal

Canopy:

100 % polyester,
ca. 180 g/m², rot-proof,
water-repellent impregnation,
without valance, with air vent,
removable for washing by hand
incl. light-proof protective
sleeve with zip and rod

Frame:

anthracite grey powder-coated
aluminium/steel frame,
one-part pole 40 x 55 mm,
braces ca. 14 x 20 mm,
rotary plate for rotating 360° with foot
pedal, tilting, includes cross base for
paving slabs 50 x 50 x 5 cm
(slabs not included)

TIP: For matching accessories, please refer to page 68 – 71

Dimensions (cm)
for size 300 cm Ø:

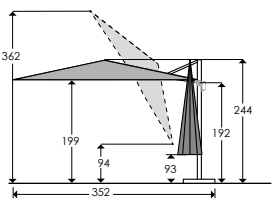

Dimensions (cm)
for size 230 x 230 cm:

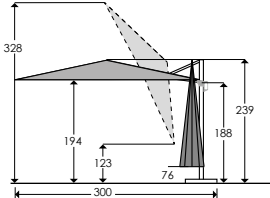

Dimensions (cm)
for size 270 x 270 cm:

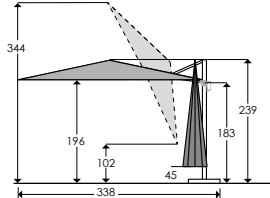

ca. 300 cm Ø	760-02 	760-77 	760-78 	760-15
ca. 230 x 230 cm	759-02 	759-77 	759-78 	759-15
ca. 270 x 270 cm	786-02 	786-77 	786-78 	786-15

Packing box:
I) 300 cm Ø
II) 230 x 230 cm
III) 270 x 270 cm

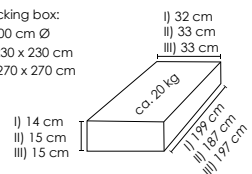

Application video Assembly instructions



Rhodos

300 x 300 cm

Art. no. 782-..



Canopy:

100 % polyester,
ca. 200 g/m², rot-proof,
water-repellent impregnation,
without valance, with air vent,
with band trim,
removable for washing by hand,
incl. light-proof protective
sleeve with zip and rod

Frame:

anthracite grey powder-coated
aluminium/steel frame,
one-part pole 53 x 77 mm,
braces ca. 17 x 25 mm, rotary plate
for rotating 360° with foot pedal,
tilting, very sturdy brace joints,
includes cross base for paving slabs
50 x 50 x 5 cm (slabs not included)

TIP: For matching accessories, please refer to page 68 – 71



Sturdy braces



Crank mechanism integrated in handle



Solid steel rotary joint with foot pedal for locking!



Dimensions (cm)

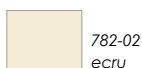
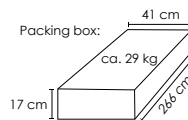
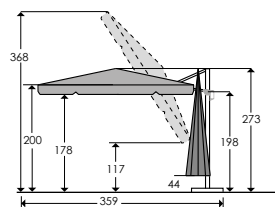

782-02
ecrú



782-05
terracotta



782-15
anthracite

ca.
300 x 300 cm



Application video

Assembly instructions



Rhodos Smart

300 x 300 cm

Art. no. 794-..



Sturdy canopy suspension



Brace joints



Rotary joint

Canopy:

100 % polyester, ca. 200 g/m², rot-proof, water-repellent impregnation, without valance, with air vent, removable for washing by hand incl. light-proof protective sleeve with zip and rod

Frame:

anthracite grey powder-coated aluminium frame, one-part pole ca. 58 x 93 mm, braces ca. 17 x 25 mm, for rotating 360° with hand lever, opening and closing as well as continuous incline adjustment at the pole, effortless operation with crank system, includes cross base for paving slabs 50 x 50 x 5 cm (slabs not included)

TIP: For matching accessories, please refer to page 68 – 71

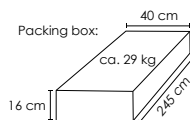
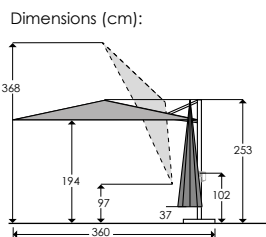

794-02
ecru



794-14
silver grey

ca.
300 x 300 cm



Application video



Assembly instructions



Open, close and
incline
via crank system



Wheelchair friendly*
thanks to lower operating
height and no
foot control.

* when used with a universal
mount Page 69



Open
Close



Incline

Rotate by 360°
via hand lever

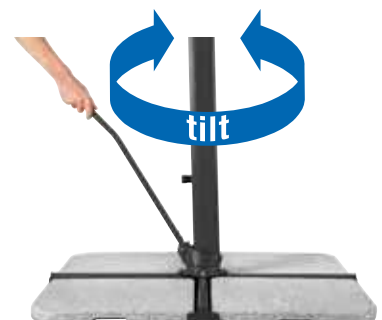

Rhodos Twist

300 x 300 cm 350 x 260 cm
 Art. no. 730-.. Art. no. 732-..



Pivoting umbrella canopy



Handle for opening, inclining, tilting



Solid rotary joint with foot pedal

Canopy:

100 % polyester, ca. 200 g/m², rot-proof, water-repellent impregnation, without valance, with air vent, removable for washing by hand incl. light-proof protective sleeve with zip and rod

Frame:

anthracite grey powder-coated aluminium/steel frame, one-part pole 53 x 80 mm, braces ca. 26 x 18 mm, rotary plate for rotating 360° with foot pedal, tilting, tilts sideways along the arm, includes cross base for 50 x 50 x 5 cm paving slabs (slabs not included)

Adjustable in 3 dimensions:

1. Rotary plate for rotating 360° with foot pedal
2. Tilts up to 50° along the pole
3. Can be tilted on both sides up to 45° along the radial arm (by handle)

TIP: For matching accessories, please refer to page 68 – 71

Also available with recycled canopy (see page 53)

Dimensions (cm) for size 300 x 300 cm:

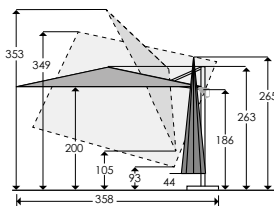

Dimensions (cm) for size 350 x 260 cm:

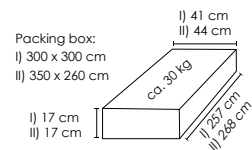
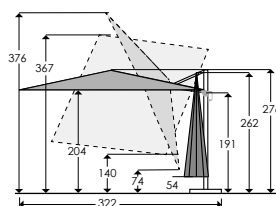

ca. 300 x 300 cm	730-02 ecru	730-08 bordeaux	730-14 silver grey	730-15 anthracite
ca. 350 x 260 cm	732-02	-	-	732-15

Application video



Assembly instructions



Rhodos Twist Woody

300 x 300 cm

Art. no. 729-..

Aluminium
frame in
wood look



Canopy:

100 % polyester, ca. 200 g/m², rot-proof, water-repellent impregnation, without valance, with air vent, removable for washing by hand incl. light-proof protective sleeve with zip and rod

Frame:

powder-coated aluminium/steel frame in wood look, one-part pole ca. 53 x 80 mm, braces ca. 26 x 18 mm, rotary plate for rotating 360° with foot pedal, tilting, tilts sideways along the arm, includes cross base for 50 x 50 x 5 cm paving slabs (slabs not included)

Pivoting umbrella canopy



Handle for opening, inclining, tilting



Solid rotary joint with foot pedal

Adjustable in 3 dimensions:

1. Rotary plate for rotating 360° with foot pedal
2. Tilts up to 50° along the pole
3. Can be tilted on both sides up to 45° along the radial arm (by handle)

TIP: For matching accessories, please refer to page 68 – 71



Dimensions (cm):

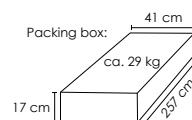
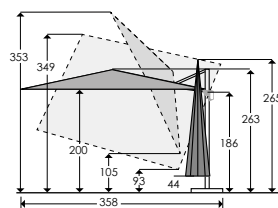

729-02
ecru



729-15
anthracite

ca.
300 x 300 cm



Application video



Assembly instructions



Rhodos Twist Loft

300 x 300 cm

Art. no. 672-..

Modern
linen
structure



New



Canopy:

100 % polyester, ca. 200 g/m², rot-proof, water-repellent impregnation, without valance, with air vent, removable for washing by hand incl. light-proof protective sleeve with zip and rod

Frame:

powder-coated aluminium/steel frame in wood look, one-part pole ca. 53 x 80 mm, braces ca. 26 x 18 mm, rotary plate for rotating 360° with foot pedal, tilting, tilts sideways along the arm, includes cross base for 50 x 50 x 5 cm paving slabs (slabs not included)

Pivoting umbrella canopy

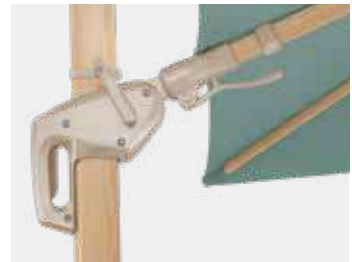

Handle for opening, inclining, tilting



Solid rotary joint with foot pedal

Adjustable in 3 dimensions:

1. Rotary plate for rotating 360° with foot pedal
2. Tilts up to 50° along the pole
3. Can be tilted on both sides up to 45° along the radial arm (by handle)

TIP: For matching accessories, please refer to page 68 – 71

Dimensions (cm):

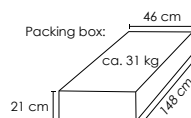
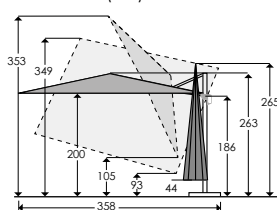

672-95
ecrú

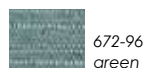

672-96
green

ca.
300 x 300 cm



Application video



Assembly instructions



Rhodos Grande

400 cm Ø
Art. no. 789-..

400 x 300 cm
Art. no. 787-..



Sturdy canopy suspension



Crank mechanism integrated in handle



Solid rotary joint with foot pedal

Canopy:

100 % polyester, ca. 200 g/m², rot-proof, water-repellent impregnation, without valance, with air vent, removable for washing by hand incl. light-proof protective sleeve with zip and rod

Frame:

anthracite grey powder-coated aluminium frame, one-part pole 57 x 93 mm, braces ca. 17 x 25 mm, rotary plate for rotating 360° with foot pedal, tilting, includes cross base for 50 x 50 x 5 cm paving slabs (slabs not included)

TIP: For matching accessories, please refer to page 68 – 70



Dimensions (cm) for size 400 cm Ø:

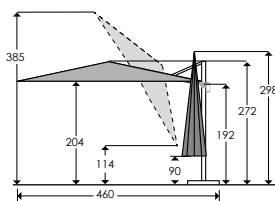

Dimensions (cm) for size 400 x 300 cm:

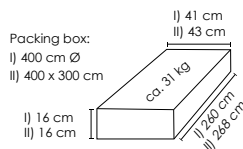
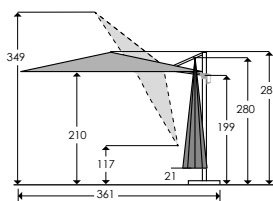

789-02
ca. 400 cm Ø



789-15
ca. 400 cm Ø



787-02
ca. 400 x 300 cm

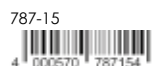

787-15
ca. 400 x 300 cm

Application video



Assembly instructions



Rhodos Blacklight

300 cm Ø
Art. no. 793-15



LED light strips
in the braces



Solar top



Braces with LED light strips



Crank mechanism integrated in handle

Solid rotary joint with foot pedal

Canopy:

100 % polyester, ca. 180 g/m², rot-proof, water-repellent impregnation, without valance, with air vent, removable for washing by hand incl. light-proof protective sleeve with zip and rod

Frame:

anthracite grey powder-coated aluminium frame, one-part pole 67 x 50 mm, braces 13 x 19 mm, LED light strips in the braces (the included batteries are charged by a solar module on the canopy or with the included USB cable, battery charge lasts ca. 6 hours), rotary plate for rotating 360° with foot pedal, tilting, includes cross base for 50 x 50 x 5 cm paving slabs (slabs not included)

TIP: For matching accessories, please refer to page 68 – 71



Dimensions (cm):

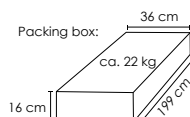
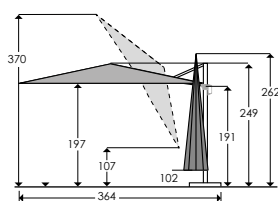

ca.
300 cm Ø

793-15
anthracite



Application video



Assembly instructions



Rhodos Rondo

350 cm Ø

Art. no. 792-..



Braces and pole curved

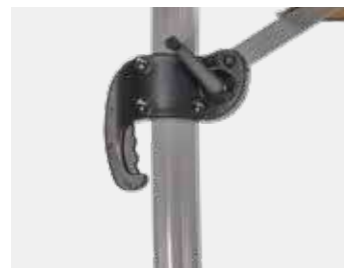

Adjustable inclination



Solid rotary joint with foot pedal

Canopy:

100 % polyester, ca. 200 g/m², rot-proof, water-repellent impregnation, without valance, with air vent, removable for washing by hand, with band trim, incl. light-proof protective sleeve with zip and rod

Frame:

silver grey powder-coated aluminium frame, one-part pole 53 x 77 mm, rotates 360°, tilting, braces ca. 14 x 24 mm, very sturdy brace joints, includes cross base f or 50 x 50 x 5 cm paving slabs (slabs not included)

TIP: For matching accessories, please refer to page 68 – 71

Dimensions (cm):

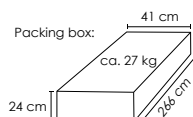
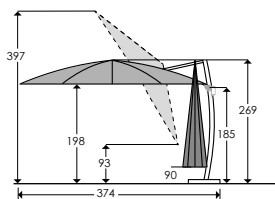

792-16 sand



792-08 bordeaux



792-15 anthracite

ca. 350 cm Ø



Application video



Assembly instructions



Muro

250 cm Ø

Art. no. 617-..

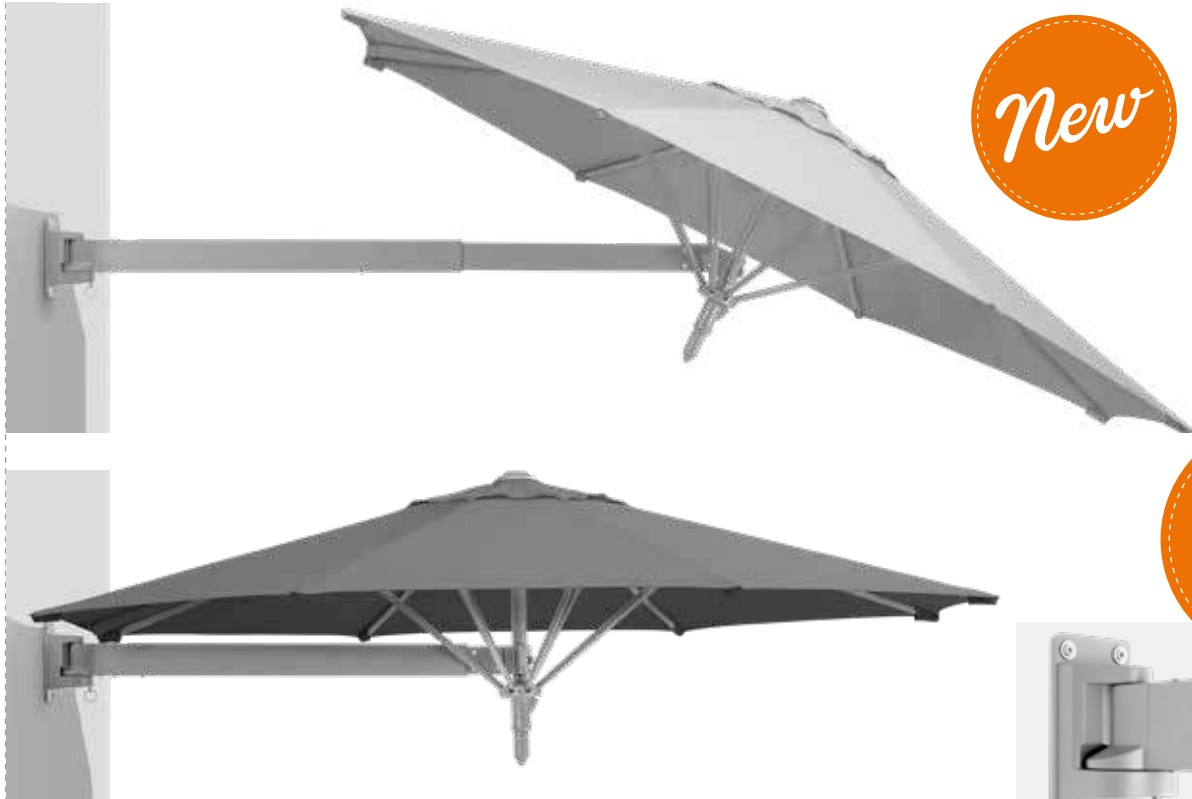

Canopy:

100 % polyester, ca. 180 g/m², rot-proof, water-repellent impregnation, with air vent, removable for washing by hand incl. light-proof protective sleeve with hook and loop fastener and rod

Frame:

silver grey powder-coated aluminium frame, extension arm ca. 40 x 80 mm, 55 cm extendable, easy-to-operate slider with button, tilt mechanism with button, braces ca. 18 x 12 mm, 180° swivelling, lockable in 9 positions, umbrella detachable from the boom

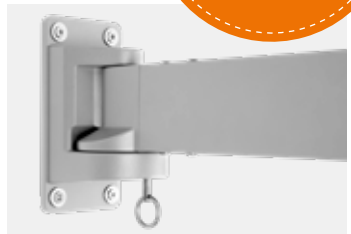

Sturdy mounting plate



Closes in tight spaces



Slider with button



Dimensions (cm):

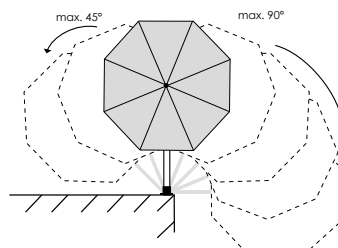
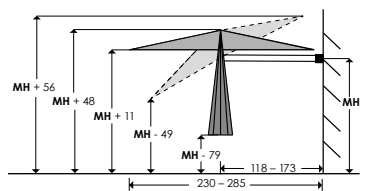

MH =



ca.
250 cm Ø



Application video



Assembly instructions





SCHNEIDER
GREEN STYLE



REUSE

Canopy made of recycled PET



PET BOTTLES ARE COLLECTED, CLEANED, ...

...AND PROCESSED INTO GRANULES.



THE GRANULATE IS HEATED AND MELTED. FROM THIS, THE POLYESTER FIBERS ARE FORMED, ...



...FROM WHICH WE MAKE THE COVERING FOR OUR GREEN STYLE UMBRELLAS.

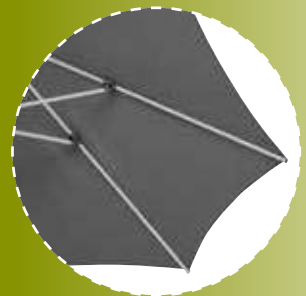

GREEN STYLE

Rhodos Twist

GREEN STYLE

300 x 300 cm
 Art. no. 727-15



Canopy:

100 % recycled PET, ca. 200 g/m², rot-proof, water-repellent impregnation, without valance, with air vent, removable for washing by hand incl. light-proof protective sleeve made of 100% recycled PET with zip and rod

Frame:

anthracite grey powder-coated aluminium/steel frame, one-part pole 53 x 80 mm, braces ca. 26 x 18 mm, rotary plate for rotating 360° with foot pedal, tilting, tilts sideways along the arm, includes cross base for 50 x 50 x 5 cm paving slabs (slabs not included)

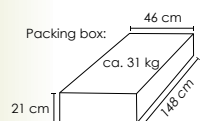

Application video



Assembly instructions



Details about UV protection, dimensions etc. analogous to the Rhodos Twist umbrella on page 44.

Venedig

GREEN STYLE

270 cm Ø
 Art. no. 726-15

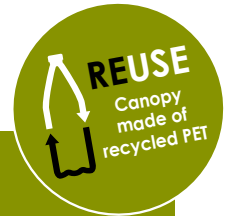

Canopy:

100 % recycled PET, ca. 180 g/m², rot-proof, water-repellent impregnation, without valance, with air vent, removable for washing by hand

Frame:

silver grey powder-coated aluminium frame, round braces with 16 mm Ø, crank, metal tilt mechanism, two-part pole 38 mm Ø



Details about UV protection, dimensions etc. analogous to the Venedig umbrella on page 24.





SCHNEIDER
SUNNY

The sunny line of umbrellas is ideal for advertising campaigns, supplements or secondary placement. EU and Asian imports, stringently tested in accordance with Schneider quality standards, guarantee functional and durable umbrellas.

The “sunny” sales display

allows the orderly display of the sunny products on page 56 – 58 – just where you need it: with the product assortment, as a secondary display or at the point of sale.

The display is delivered empty and must be assembled!

Art no. 934-00



Shorty

180 cm Ø
Art. no. 616-00

Canopy:

100 % polyester, ca. 140 g/m², rot-proof, water-repellent impregnation, with valance, 3 different stripe designs

Frame:

white powder-coated steel frame, three-part pole part 19/22 mm, folding mechanism for compact transport size (ca. 65 cm), includes carrying bag of the same fabric, with strap

Packaging unit: 12 items

(The "sunny" sales display on page 55 is designed for 2 packaging units = 24 items)



The ideal
travel
umbrella



All single parts can be stowed in practical carrying bag.

Small size
ca. 65 cm



Easy

180 cm Ø
Art. no. 767-00

Canopy:

nylon, in practical carrying bag with carrying strap, assorted colours: berry, mandarin, apple green, blue

Frame:

silver grey powder-coated steel frame, two-part pole 19/22 mm, with removable ground spike and base plate

Packaging unit: 12 items

(The "sunny" sales display on page 55 is designed for 2 packaging units = 24 items)



Ground spike and base plate for easy insertion and secure holding

The ideal
beach
umbrella



All single parts can be stowed in practical carrying bag.



Isar

180 cm Ø

Art. no. 762-00

Canopy: nylon with valance
Assorted colours: mandarin, aqua, green

Frame: white powder-coated steel frame,
two-part pole 19/22 mm, metal tilt mechanism

Packaging unit: 12 items
(The "sunny" sales display on page 55
is designed for 3 packaging units = 36 items)



Beach
umbrella
with PVC
carrying
case



Merkur

200 cm Ø

Art. no. 740-00

Canopy: 100 % polyester, ca. 160 g/m²,
rot-proof, with valance,
in assorted colours: ecru, red, apple green, blue

Frame: white powder-coated steel frame,
two-part pole 22/25 mm, metal tilt mechanism

Packaging unit: 12 items
(The "sunny" sales display on page 55
is designed for 2 packaging units = 24 items)



Avellino

180 x 130 cm

Art. no. 611-..

Canopy: 100 % polyester, ca. 160 g/m², rot-proof, water-repellent
impregnation, removable for washing by hand, includes polyester bag

Frame: anthracite grey powder-coated steel frame,
two-part pole 25 mm Ø, rotates and tilts in all directions,
adjustable up to 56 cm sideways and 81 cm in height

Packaging unit: 6 items (The "sunny" sales display on page 55
is designed for 2 packaging units = 12 items)

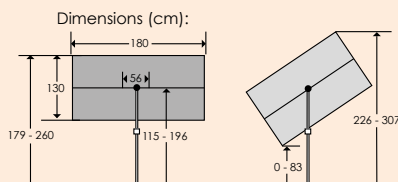

All single parts can be
stowed in practical bag.

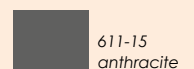
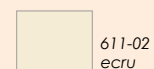

Napoli

270 cm Ø

Art. no. 707-..

Canopy:

100 % polyester, ca. 160 g/m², rot-proof, water-repellent impregnation, without valance, with air vent, removable for washing by hand

Frame:

anthracite grey powder-coated steel frame, two-part pole 38 mm Ø, 12 x 18 mm braces, crank, metal tilt mechanism

Packaging unit: 4 items

(The "sunny" sales display on page 55 is designed for 2 packaging units = 8 items)



Slider with button Crank



707-02
ecru



707-15
anthracite



Dimensions (cm):

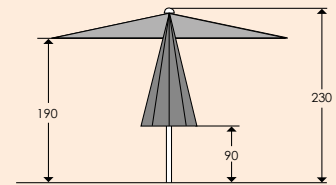

Bergamo

300 cm Ø

Art. no. 625-..

Canopy:

100 % polyester, ca. 160 g/m², rot-proof, water-repellent impregnation, without valance, with air vent, removable for washing by hand

Frame:

anthracite grey powder-coated steel frame, two-part pole 38 mm Ø, 12 x 18 mm braces, crank

Packaging unit: 10 items in single box



Powder-coated steel frame Crank



625-02
ecru



625-05
terracotta



625-15
anthracite



Dimensions (cm):

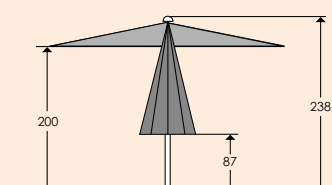

Venus

300 cm Ø

Art. no. 772-..



Canopy:

100 % polyester, ca. 160 g/m², rot-proof, water-repellent impregnation, without valance, with air vent

Frame:

anthracite grey powder-coated steel frame, two-part pole 48 mm Ø, braces ca. 12 x 18 mm, includes cross base for paving slabs 40 x 40 x 5 cm (slabs not included)

Packaging unit: 18 items in single box

Matching protective sleeve: 813-00 (page 79)



Powder-coated steel frame



Crank



772-02 ecru



772-15 anthracite



Dimensions (cm):

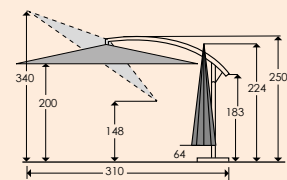

Genua

300 cm Ø

Art. no. 630-..

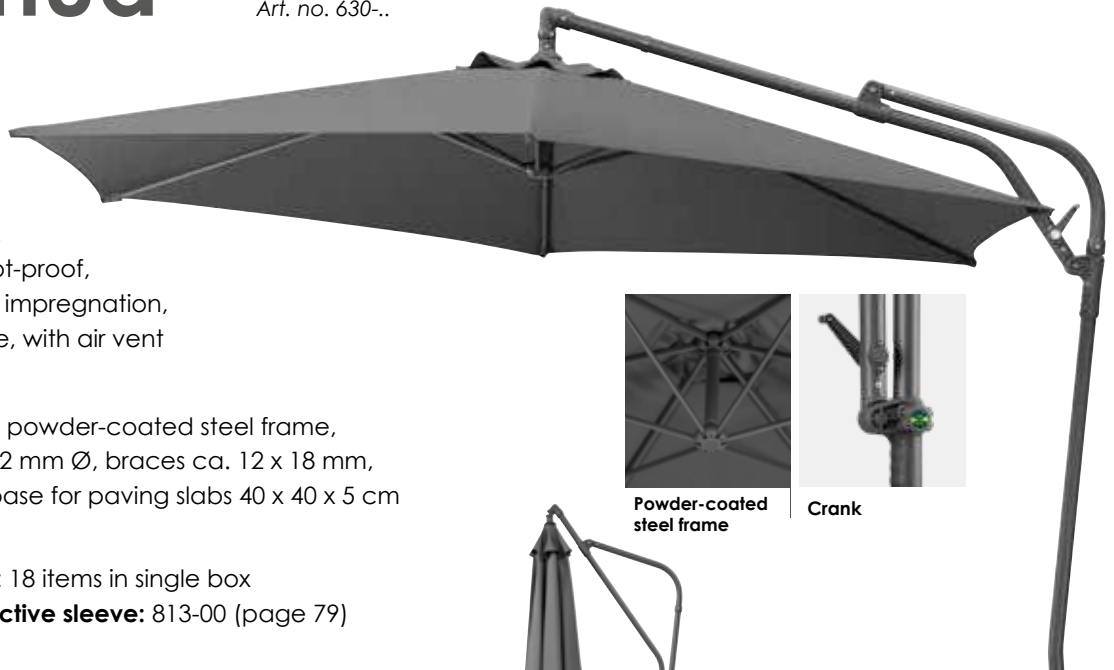

Canopy:

100 % polyester, ca. 160 g/m², rot-proof, water-repellent impregnation, without valance, with air vent

Frame:

anthracite grey powder-coated steel frame, two-part pole 42 mm Ø, braces ca. 12 x 18 mm, includes cross base for paving slabs 40 x 40 x 5 cm (slabs not included)

Packaging unit: 18 items in single box

Matching protective sleeve: 813-00 (page 79)



Powder-coated steel frame



Crank



630-02 ecru



630-05 terracotta



630-15 anthracite

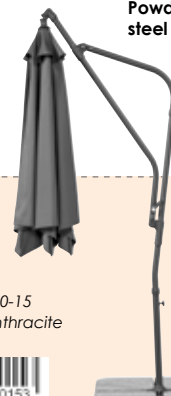

Dimensions (cm):

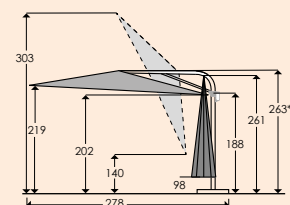

* At least 275 cm necessary for opening the umbrella



Wide variety
of combination
options

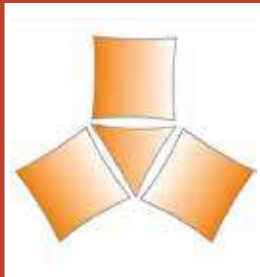
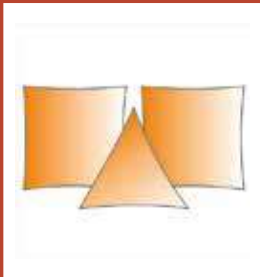



Shade sails

Schneider shade sails of tear-resistant HDPE fabric or 100 % polyester feature impressive quality and versatility!



Teneriffa – HDPE fabric, various shapes and sizes (page 62)



Lanzarote – 100 % polyester, various shapes and sizes (page 63)

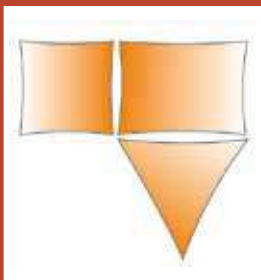

Teneriffa

ca. 360 x 360 x 360 cm

Art. no. 230-..

ca. 360 x 360 cm

Art. no. 232-..

ca. 500 x 500 x 500 cm

Art. no. 231-..

ca. 500 x 500 cm

Art. no. 233-..

ca. 360 x 250 cm

Art. no. 234-..

ca. 500 x 360 cm

Art. no. 235-..



High-quality tear-resistant HDPE fabric,
ca. 185 g/m², rot-proof, highly fade-resistant,
water-repellent, wind and water permeable,
UV protection ca. 90 %, 3 or 4 stainless steel fastening rings,
reinforced and tear-resistant edge seam,
convex edges for good fit,
includes fastening rope ca. 10 m

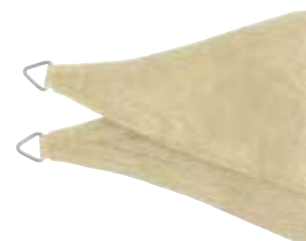

Fastening rings of stainless steel



Fastening rope ca. 10 m

Shapes, sizes and colours:

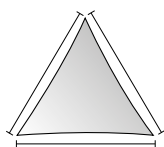

ca. 360 x 360 x 360 cm
Packaging unit: 1 item

ca. 500 x 500 x 500 cm
Packaging unit: 1 item

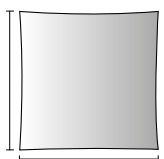

ca. 360 x 360 cm
Packaging unit: 1 item

ca. 500 x 500 cm
Packaging unit: 1 item

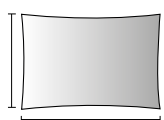

ca. 360 x 250 cm
Packaging unit: 1 item

ca. 500 x 360 cm
Packaging unit: 1 item



...-02
ecru



...-14
silver grey



230-02

4 000570 230025



230-14

4 000570 230148



231-02

4 000570 231022



231-14

4 000570 231145



232-02

4 000570 232029



232-14

4 000570 232142



233-02

4 000570 233026



233-14

4 000570 233149



234-02

4 000570 234023



234-14

4 000570 234146



235-02

4 000570 235020



235-14

4 000570 235143

Lanzarote

ca. 360 x 360 x 360 cm

Art. no. 240-..

ca. 400 x 400 x 300 cm

Art. no. 241-..

ca. 300 x 250 cm

Art. no. 242-..

ca. 360 x 360 cm

Art. no. 244-..

Polyester



100 % polyester,
 rot-proof, water-repellent impregnation,
 UV protection ca. 50 %,
 3 or 4 stainless steel eyelets,
 double sewn edge seam,
 includes fastening rope ca. 10 m



Stainless steel eyelets



Fastening rope ca. 10 m

SHADE SAILS

Shapes, sizes and colours:

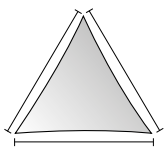
 ca. 360 x 360 x 360 cm
 Packaging unit: 4 items

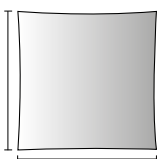
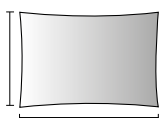
 ca. 400 x 400 x 300 cm
 Packaging unit: 4 items

 ca. 360 x 360 cm
 Packaging unit: 2 items

 ca. 300 x 250 cm
 Packaging unit: 4 items

Clamping anchor

for guying shade sails,
made of stainless steel
hooks on both sides
length 150 – 218 mm

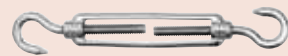

Art. no. 250-10



Packaging unit: 5 items

D-shackle

for fastening shade sails,
made of stainless steel
6 mm Ø, inner width 12 mm



Art. no. 250-20



Packaging unit: 5 items

Holding eyelet

for fastening shade sails,
made of stainless steel
Slab: 65 x 40 mm, hole Ø 5 mm
Eyelet: 28 mm high, 6 mm Ø



Art. no. 250-30



Packaging unit: 5 items

Eyelet bolt

for fastening shade sails,
made of stainless steel,
includes 2 nuts and 2 flat washers
Total length: 140 mm
Thread: M6 x 100 mm
Eyelet: 30 mm outer Ø



Art. no. 250-40



Packaging unit: 5 items

Snap connector

for fastening shade sails,
made of stainless steel
6 x 60 mm



Art. no. 250-50



Packaging unit: 5 items

Tension spring

for guying shade sails,
made of stainless steel
great stability, tensile force: 300 N
Length ca. 145 mm



Art. no. 250-60



Packaging unit: 5 items

Pole

for fastening shade sails,
made of steel, hot galvanised, great stability,
ca. 60 mm Ø, height ca. 241 cm,
rotates 360° for ideal alignment
in the ground plate, fastening point
continuously height adjustable
from 145 cm to 230 cm, includes
cable hoist with 5 m fastening rope
and snap connector including rope
clip and cleat
matching our universal
ground plate
(Art. no. 897-00)
matching our universal
ground anchor
(Art. no. 897-50)

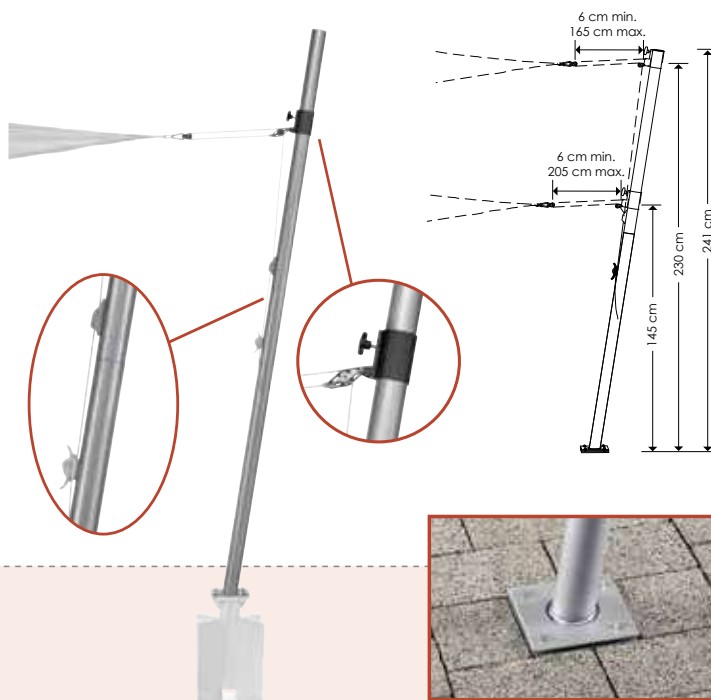

Art. no. 251-00



Packaging unit: 1 item

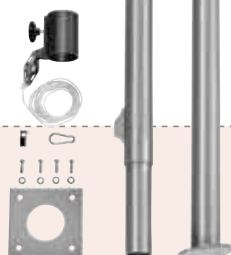

Sales display

for shade sails and accessories

Free-standing metal display on a EURO pallet with informative sign on top and room for scanner labels. Delivered assembled and fully equipped.

Art. no.: 937-00



Standard layout front Teneriffa shade sail

Quantity	Article number	Designation and size	Colour
2 items	230-02	360x360x360 cm	ecru
2 items	230-14	360x360x360 cm	silver grey
2 items	231-02	500x500x500 cm	ecru
2 items	231-14	500x500x500 cm	silver grey
2 items	232-02	360x360 cm	ecru
2 items	232-14	360x360 cm	silver grey
2 items	233-02	500x500 cm	ecru
2 items	233-14	500x500 cm	silver grey
2 items	234-02	360x250 cm	ecru
2 items	234-14	360x250 cm	silver grey
2 items	235-02	500x360 cm	ecru
2 items	235-14	500x360 cm	silver grey

Standard layout rear Lanzarote shade sail & accessories

Quantity	Article number	Designation and size	Colour
4 items	240-02	360x360x360 cm	ecru
4 items	240-14	360x360x360 cm	silver grey
4 items	240-77	360x360x360 cm	red
4 items	241-02	400x400x300 cm	ecru
4 items	241-14	400x400x300 cm	silver grey
4 items	241-78	400x400x300 cm	apple green
4 items	242-02	300x250 cm	ecru
4 items	242-14	300x250 cm	silver grey
4 items	242-77	300x250 cm	red
4 items	244-02	360x360 cm	ecru
4 items	244-14	360x360 cm	silver grey
4 items	244-78	360x360 cm	apple green
5 items	250-10	Clamping anchor	
5 items	250-20	D-shackle	
5 items	250-30	Holding eyelet	
5 items	250-40	Eyelet bolt	
5 items	250-50	Snap connector	
5 items	250-60	Tension spring	
2 items	251-00	Pole	
2 items	897-00	Universal ground plate	





The practical accessories ensure secure support of your Schneider umbrellas wherever they are used. Schneider umbrella accessories, like all other Schneider products, are carefully inspected for quality and workmanship.

The new standardised packaging enhances the appearance to boost sales at the point of sale.

NEW in Accessories:



Steel
balcony
umbrella
stand

(page 75)

Trolley
granite
stand

(page 78)



Universal mounts

Installation on one of the mounts requires that the rotary plate (see detail images) be directly screwed onto the selected mount using the screws (M8x20) that have been included with the umbrella.

There is therefore no need for the cross base. You can store the base and use it as needed if you change locations temporarily.

The elimination of the cross base reduces the overall height of the umbrella by about 5 cm.

Our tip: Before you use one of the mounts listed, we recommend that you first use the umbrella with the included cross base for a few weeks in order to determine the ideal location for your umbrella.

- Suitable for**
- Monaco 3 x 3 m
 - Bermuda
 - Rhodos Junior series
 - Rhodos Grande
(universal ground plate + universal wall console only)
 - Rhodos Twist series
 - Rhodos
 - Rhodos Blacklight
 - Rhodos Rondo
 - Rhodos Smart
 - Genua
 - Pole for shade sail
(except universal ground stake)

Hole pattern:
Dimensions in mm

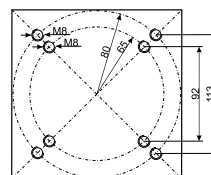

Universal wall console

For installation on walls, hot galvanised, mounting plate ca. 20 x 16 cm, great stability, space-saving installation option, size: 21 x 16 x 16 cm

Suitable for the umbrellas listed above, depending on the height of the wall and the fastening point of the universal wall console.



Art. no. 897-60



Universal ground plate

To be set in concrete

to be set in concrete,
hot galvanised,
mounting plate ca. 16 x 16 cm,
total height ca. 40 cm

Minimum dimensions for the concrete foundation:

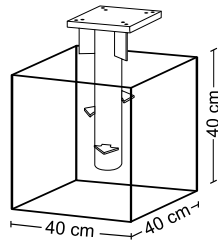

Art. no. 897-00



Universal ground anchor

For anchoring in the ground

For anchoring in the ground*
or setting in concrete,
hot galvanised,
mounting plate ca. 16 x 16 cm,
total height ca. 45 cm

Minimum dimensions for the concrete foundation:

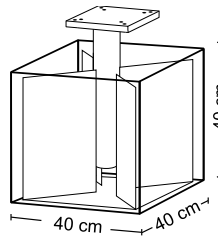

* Only in undisturbed topsoil!
Not suitable for sandy or stony soils!

Art. no. 897-50



Universal ground stake

For anchoring

For anchoring, hot galvanised,
mounting plate ca. 16 x 16 cm,
total height ca. 55 cm,
anchoring tool included



Art. no. 897-55



Hanging umbrella wind stabiliser

This wind stabiliser made of robust, black polyester straps reduces unsteadiness of the umbrella caused by wind and therefore also the strain on the umbrella frame. It can be mounted on all hanging umbrellas with a locking screw on the lower part of the pole and a maximum pole circumference of 260 mm, without the use of tools.

IMPORTANT:

The hanging umbrella wind stabiliser does **not** increase the stability of the hanging umbrella. The stability depends primarily on the weight and the size of the umbrella stand that is used! The wind stabiliser only reduces the movement of the canopy and the strain on the umbrella frame. The hanging umbrella should always be closed in windy conditions.

Suitable for the following hanging umbrellas:

- Monaco 3 x 3 m • Bermuda
- Rhodos Grande • Rhodos Twist series
- Rhodos • Rhodos Blacklight • Rhodos Rondo
- Rhodos Smart

Scope of delivery:

- 1x pole fastener
- 2x brace fasteners
- 2x tie-down straps

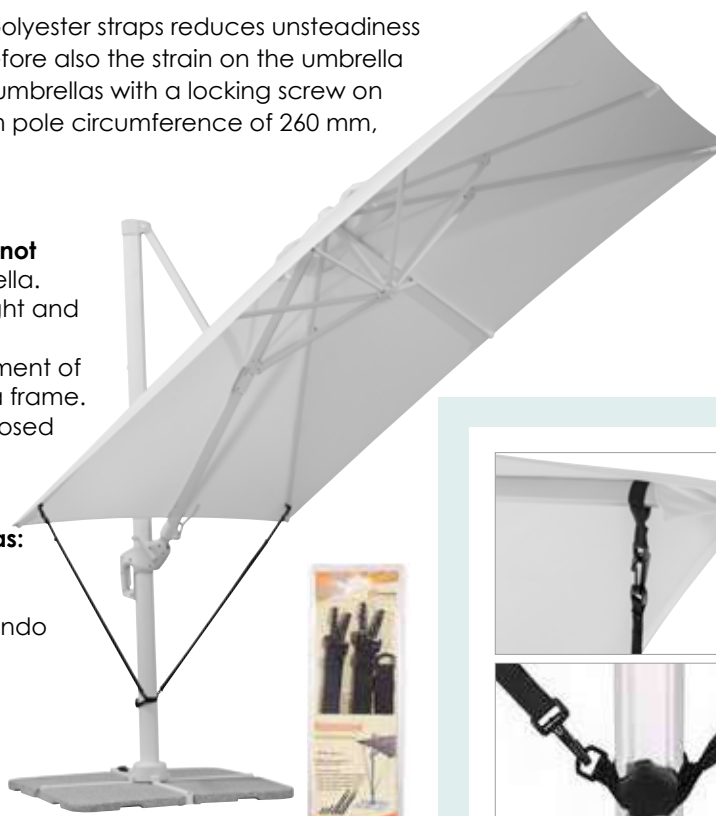

Art. no. 313-00



Packaging unit: 6 items

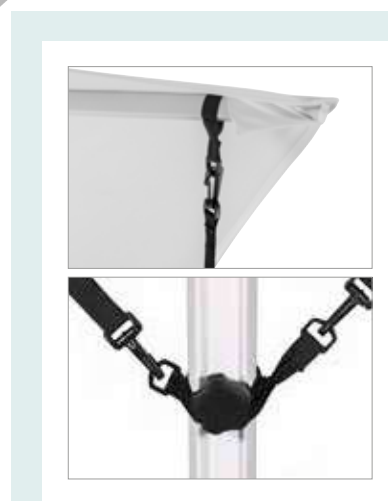

Slabs for hanging umbrellas

Slabs suitable for cross bases of hanging umbrellas. For filling with water from the side. Filled 100 kg and therefore suitable for hanging umbrellas. Walkable! The interlocking design creates a continuously connected unit. Overall height of the umbrella is about 5cm higher.

Suitable for our umbrellas:

- Monaco 3 x 3 m • Bermuda • Rhodos Junior series
- Rhodos Twist-Serie • Rhodos • Rhodos Blacklight
- Rhodos Rondo • Genua

1 set consists of 4 elements.
Total size ca. 111 x 111 x 12 cm
Empty weight: ca. 12 kg/set

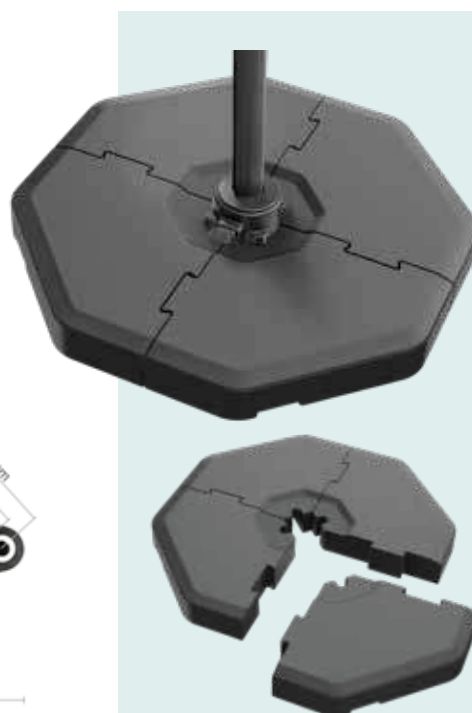

Dimensions
of the spacer
plate:

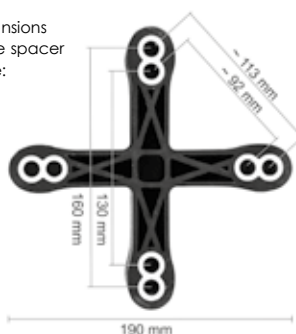

Art. no. 312-15

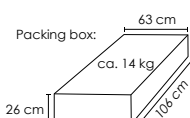

Stand for hanging umbrellas, mobile

Sturdy frame of powder-coated steel with foot pedal for raising, anthracite grey plastic cover colour matched to our hanging umbrellas, 4 PU-coated steering rollers, 5 plastic tanks for filling with sand and/or water, total weight ca. 110 kg (with sand) or ca. 90 kg (with water), overall height of umbrella is about 15 cm higher.

Suitable for our umbrellas:

- Monaco 3 x 3 m
- Bermuda
- Rhodos Junior series
- Rhodos
- Rhodos Twist series
- Rhodos Blacklight
- Rhodos Rondo
- Rhodos Smart

Hole pattern for mounting the umbrella holder.

Dimensions in mm:

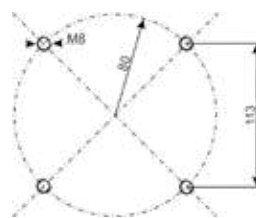

Ready to move when foot pedal is pressed



Plastic tanks and rollers

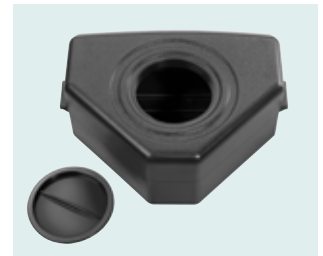

Plastic tank for filling



Umbrella not included

Art. no. 319-15

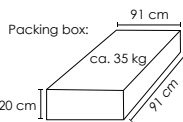

Steering bar for mobile stands for hanging umbrellas

Allows effortless movement of the mobile hanging umbrella stand by mounting between the rotating plate of the umbrella and the mounting plate of the umbrella stand.

Rod is collapsible.

Can also be retrofitted in existing hanging umbrella stands (Art. no. 319-15).

Can also be used with other mobile umbrella stands with a suitable hole pattern.

Hole pattern for mounting.

Dimensions in mm:

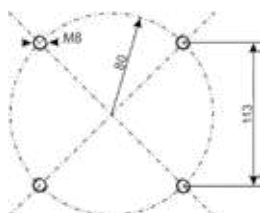

Art. no. 319-50



Umbrella and umbrella stand not included



Table clamp

made of galvanised steel,
for poles up to 32 mm Ø
Clamping area: round profiles: 40 mm Ø
Flat profiles: 38 mm Ø



Art. no. 801-00



Blister packaging made of recycled PET bottles.
Packaging unit: 12 items

Balcony clamp

made of galvanised steel,
Clamping area: 190 mm

for vertical mounting: for poles up to 25 mm Ø
for horizontal mounting: for poles up to 32 mm Ø
(For poles up to 38 mm Ø only approved
for use with additional balcony stand or
second balcony clamp.)

Art. no. 802-00



Blister packaging made of recycled PET bottles.
Packaging unit: 6 items



Lawn spike

made of galvanised steel,
for poles up to 25 mm Ø

Art. no. 803-00



Blister packaging made of recycled PET bottles.
Packaging unit: 6 items



Lower poles



25 mm Ø
(inside:
23 mm Ø)



30 mm Ø
(inside:
28 mm Ø)



Packaging unit: 6 items



25 mm Ø
(inside:
23 mm Ø)



Packaging unit: 6 items



25 mm Ø
(inside:
23 mm Ø)



30 mm Ø
(inside:
28 mm Ø)



Packaging unit: 6 items

ACCESSORIES

Ground sleeve

of anodised aluminium,
for poles with 38 - 50 mm Ø
for large umbrellas up to 400 cm Ø

Blister packaging
made of recycled
PET bottles.

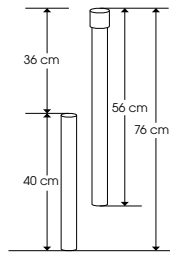

Art. no. 827-00



Packaging unit: 4 items



Ground screw

made of galvanised steel,
for 38 - 58 mm Ø poles,
3 sturdy centring screws,
total length: 50 cm



Art. no. 888-00



Packaging unit: 6 items



Four-peg lawn anchor

made of galvanised steel,
collapsible, disassembled on delivery,
for 25 - 38 mm Ø poles,
for umbrellas up to 300 cm Ø



Art. no. 863-00



Packaging unit: 4 items



Umbrella holders

Foxi and Maxi



Innovative umbrella mounts for stable and secure mounting of sun umbrellas on balcony rails. The two half shells of the umbrella holder are each securely held by four screws, fastening the umbrella pole securely to the balcony rail.

The Allen key needed for this is included.

Fibre-reinforced plastic provides maximum stability and an aesthetic design with no edges or corners.

Blister packaging made of recycled PET bottles.



Foxi umbrella holder



Combinations:

Umbrella poles with...	25 mm Ø	30 mm Ø	32 mm Ø	38 mm Ø
Round tube 5/4" (42.4 mm Ø)	yes	yes	yes	no

Art. no. 804-00



Maxi umbrella holder



Combinations:

Umbrella poles with...	25 mm Ø	30 mm Ø	32 mm Ø	38 mm Ø
Round tube 1" (33.7 mm Ø)	yes ¹⁾	yes ¹⁾	yes ¹⁾	yes
Round tube 5/4" (42.4 mm Ø)	yes ¹⁾	yes	yes	yes
Square tube 35 x 35 mm	yes	yes	yes	yes
Rectangular tube 50 x 30 mm	yes	yes	yes	yes ²⁾
Flat steel 40 x 6 mm	yes ¹⁾	yes ¹⁾	yes ¹⁾	yes
Flat steel 50 x 6 mm	yes	yes	yes	yes
T-profile 40 x 40 x 6 mm	yes	yes	yes	yes

¹⁾ Only with M8x70 screws (M8x90 screws are included)

²⁾ Only with M8x100 screws (M8x90 screws are included)

Art. no. 807-00



Granite balcony umbrella stand

ca. 25 kg granite

polished granite surface, stainless steel tube with press-in tab, for 25 - 40 mm Ø poles
for centre-pole umbrellas up to 200 cm Ø and small rectangular umbrellas

Art. no. 865-00
Granite



Packaging unit: 10 items



Concrete balcony umbrella stand

ca. 20 kg concrete

plastic casing filled with concrete, for poles with 25 - 32 mm Ø, for centre-pole umbrellas up to 200 cm Ø and small rectangular umbrellas

Art. no. 889-14
silver grey



Packaging unit: 10 items

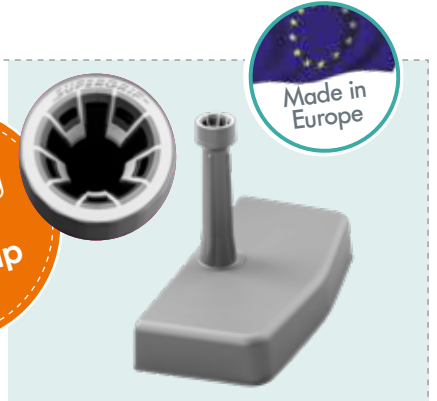

PE balcony stand

ca. 25 ltr., for filling with water

for 25-32 mm Ø poles, for centre-pole umbrellas up to 200 cm Ø and small rectangular umbrellas, to be filled with sand or water

Art. no. 862-15
anthracite



Packaging unit: 5 items



Balcony cross base

for poles with 30-40 mm Ø, for 40 x 40 cm or 50 x 50 cm paving slabs, for centre-pole umbrellas up to 250 cm Ø and small rectangular umbrellas, (slabs not included)

Art. no. 864-00



Packaging unit: 4 items

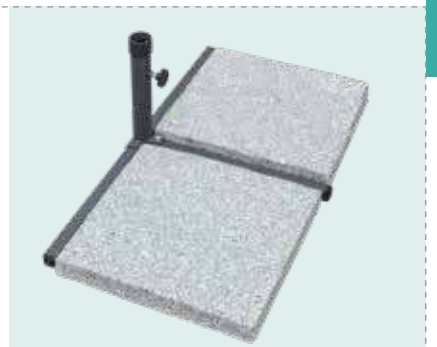

Steel balcony umbrella stand

ca. 23 kg steel

silver grey powder-coated flat steel plate with a thickness of 15 mm, stainless steel tube with press-in tab, for 25 - 40 mm Ø poles, rubber feet to protect the ground, for centre-pole umbrella up to 200 cm Ø and small rectangular umbrellas

Art. no. 332-14
silver grey



Packaging unit: 10 items



PE stands *for water*

ca. 20 litres for poles from 25 - 32 mm Ø,
to be filled with sand or water
Packaging unit: 5 items, minimum order quantity: 60 items

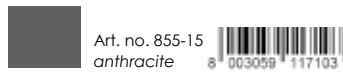
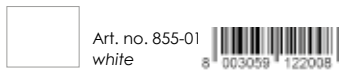

ca. 45 litre, for poles from 38 - 50 mm Ø, to be filled
with sand or water, with roller
Packaging unit: 3 items, minimum order quantity: 36 items



PE stands *for sand*

ca. 45 kg
with rollers and recessed handle,
for 30 - 50 mm Ø poles,
for centre-pole umbrellas up to 300 cm Ø



Packaging unit: 4 items

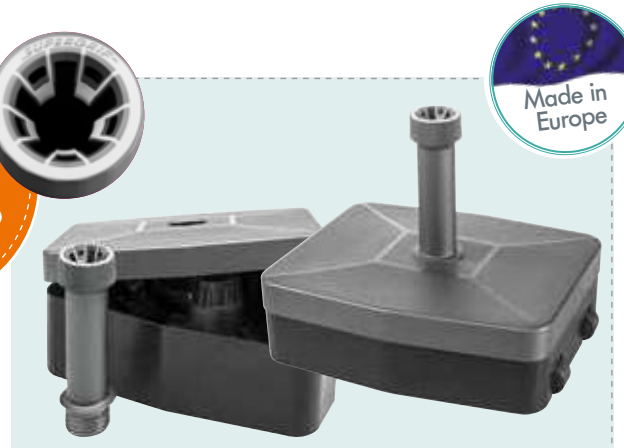

Cross base Standard

for 25 - 50 mm Ø poles
for 40 x 40 or 50 x 50 cm paving slabs
for large umbrellas up to 400 cm Ø
(slabs not included)



Packaging unit: 4 items



Cross base Plus

for 38 - 50 mm Ø poles
for 40 x 40 cm paving slabs
for large umbrellas with a diameter
of up to 400 cm or large rectangular umbrellas
Tube with 2 screws and press-in tab
(slabs not included)



Packaging unit: 4 items



Concrete stand

ca. 20 kg, for poles with 25 - 32 mm Ø,
for centre-pole umbrellas up to 200 cm Ø and
small rectangular umbrellas, plastic sleeve,
with recessed handles



ca. 20 kg

Packaging unit: 10 items



Art. no. 877-14
silver grey



Art. no. 877-15
anthracite



Concrete stand

ca. 30 kg, for 30 - 40 mm Ø poles,
for centre-pole umbrellas up to 250 cm Ø
and large rectangular umbrellas, plastic sleeve,
with recessed handles



ca. 30 kg

Packaging unit: 10 items



Art. no. 878-15
anthracite



Concrete stand

ca. 40 kg, for 30 - 50 mm Ø poles,
for centre-pole umbrellas up to 300 cm Ø,
plastic sleeve, roller, handle



ca. 40 kg

Packaging unit: 6 items



Art. no. 898-15
anthracite



Granite stand

polished granite surface, stainless steel tube,
no need for plastic reduction rings,
two recessed handles on sides

ca. 30 kg, round

for poles with 25 - 40 mm Ø, for centre-pole umbrellas
up to 250 cm Ø and small rectangular umbrellas

Art. no. 867-00



Packaging unit: 10 items



Granite stand

polished granite surface, stainless steel tube,
no need for plastic reduction rings,
two recessed handles on sides

ca. 42 kg, square

for poles with 38 - 50 mm Ø, for centre-pole umbrellas
up to 360 cm Ø

Art. no. 869-00



Packaging unit: 10 items



Trolley granite stand

polished granite surface,
stainless steel tube with reducing rings
made of robust plastic,
two integrated wheels and a practical
extendable handle allow for effortless movement,
two recessed handles on sides,
rubber feet to protect the ground

ca. 45 kg, square

for poles with 32 - 48 mm Ø,
for centre-pole umbrellas up to 360 cm Ø

Art. no. 333-00



Packaging unit: 10 items



New

With roll
and
practical
handle

Protective sleeves

for sun & market umbrellas

100% polyester, light-proof for perfect protection against UV radiation and fading of the umbrella, water-repellent coating, breathable

Blister packaging made of recycled PET bottles.
Packaging unit: 6 items

135 x 20/25 cm Art. no. 817-00 for umbrellas up to 200 cm Ø



183 x 25/35 cm Art. no. 821-00 for umbrellas up to 300 cm Ø with zip and rod



250 x 27/44 cm Art. no. 833-00 for umbrellas up to 400 cm Ø with zip and rod



for umbrellas up to 200 cm Ø

for umbrellas up to 300 cm and 400 cm Ø, with zip and rod



Protective sleeves

for hanging umbrellas

100% polyester, light-proof for perfect protection against UV radiation and fading of the umbrella, water-repellent coating, breathable

Blister packaging made of recycled PET bottles.
Packaging unit: 6 items

206 x 35/38 cm Art. no. 813-00 for hanging umbrella up to 300 cm Ø with zip



240 x 57 cm Art. no. 813-40 for hanging umbrellas up to 400 cm Ø, 300 x 300 cm and 350 x 260 cm, with zip and rod



for hanging umbrellas up to 300 cm Ø, with zip

for hanging umbrellas up to 400 cm Ø, 300 x 300 cm and 350 x 260 cm, with zip and rod

POS displays



Product assortment banner
Art. no. 896-00

Scanner strips for
- article label
- price label



Grid insert for accessories



- ideal for small presentations
- right next to the umbrellas
- no additional floor space needed

Art. no. 935-00

Sales displays for sun umbrellas

- Provides space for:**
- standard umbrellas with 25 - 32 mm tube Ø
 - market umbrellas with 38 mm tube Ø
 - large umbrellas with 48 mm tube Ø

- Features:**
- surface area of half a EURO pallet
 - can be stocked individually
 - can be linked for uniform alignment
 - endless combinations
 - low removal height (28 cm)
 - stackable
 - washable
 - 2 scanner strips with optimal scanning position
 - no scratching of umbrella poles
 - umbrellas stand upright, saving space

Art. no. 930-00



The perfect
umbrella
presentation

SCHNEIDER Displays

NEAT AND ORDERLY!



DISPLAYS

Display for accessories



(includes double hooks)
Delivered assembled
and fully equipped.
Art. no. 940-00

Display for hanging umbrellas



(includes slanted shelf)
Delivered disassembled.
Art. no. 941-00

Display for umbrella stands















Provides space for
ca. 2 x 10 umbrella stands.
Delivered assembled
and fully equipped.
Art. no. 890-00

Display for umbrella stands



Provides space
for 15 PE 20 ltr. stands
or 9 PE 45 ltr. stands.
Size: ca. 53 x 53 x 215 cm
Art. no. 936-00

Accessories at a glance

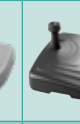
Art. no.	Model	Table clamp	Balcony clamp	Lawn spike	Four-peg lawn anchor	Ground sleeve	Ground screw	Foxi umbrella holder	Maxi umbrella holder	Protective sleeve, up to 200 cm umbrella	Protective sleeve, up to 300 cm umbrella	Protective sleeve, up to 400 cm umbrella	Granite balcony umbrella stand ca. 25 kg	Concrete balcony stand ca. 20 kg	PE balcony stand ca. 25 ltr.
															
		801-00	802-00	803-00	863-00	827-00	888-00	804-00	807-00	817-00 321-00	821-00 322-00	833-00 323-00	865-00	889-14	862-15
	Page	72	72	72	73	73	73	74	74	79	79/15	79/15	75	75	75



753-..	Aquila 200/8	8	✓	✓	✓	✓		✓	✓	✓			✓	✓	●
754-..	Aquila 250/10	8		▲		✓		▲	▲		✓		●	●	
755-..	Aquila 225 x 120	9	✓	✓		✓		✓	✓	321-00 only	✓		✓	✓	●
756-..	Aquila 265 x 150	9		▲		✓		▲	▲		✓		●	●	
775-..	Monaco 350/8	12					✓	✓							
644-..	Gemini 360/8	14					✓	✓				✓			



715-..	Locarno 150/8	18	✓	✓	✓	✓		✓	✓	✓			✓	✓	✓
716-..	Locarno 200/8	18	✓	✓	✓	✓		✓	✓	✓			✓	✓	●
717-..	Locarno 220/10	18		▲	✓	✓		▲	▲	✓			●	●	●
718-..	Locarno 180x120	18	✓	✓	✓	✓		✓	✓	✓			✓	✓	●
680-..	Ibiza 200/8	19	✓	✓	✓	✓		✓	✓	✓			✓	✓	●
681-..	Ibiza 240/8	19		▲		✓		▲	▲	✓			●	●	●
682-..	Ibiza 180 x 120	19	✓	✓	✓	✓		✓	✓	✓			✓	✓	●
620-..	Bilbao 220/6	20		▲		✓	✓	✓			✓		✓		
621-..	Bilbao 210 x 130	20		▲		✓	✓	✓			✓		✓		
640-..	Harlem 270/8	21		▲		✓	✓	✓		▲	✓		●		
783-..	Orlando 270/8	22		▲		✓	✓	✓		▲	✓		●		
790-..	Blacklight 270/8	23		▲		✓	✓	✓		▲	✓		●		
683-..	Venedig 270/8	24		▲		✓	✓	✓		▲	✓		●		
664-..	Sevilla 270/6	25		▲		✓	✓	✓		▲	✓		●		
667-..	Sevilla 240 x 140	25		▲		✓	✓	✓		▲	✓		●		
742-..	Tunis 270 x 150	26		▲		✓	✓	✓		▲	✓		●		
643-..	Porto 300 x 200	27		▲		✓	✓		▲			✓	●		
752-..	Oslo 300 x 200	28		▲		✓	✓		▲			✓	●		
688-..	Cordoba 230x150	30		▲		✓	✓	✓		▲	✓		●		
689-..	Cordoba 270/6	30		▲		✓	✓	✓		▲	✓		●		
615-..	Malaga 300 x 200	31				✓	✓					✓			
614-..	Malaga 300/8	31				✓	✓				✓				
684-..	Adria 300/8	32				✓	✓				✓				
685-..	Adria 350/8	32				✓	✓					✓			
711-..	Korsika 320/8	33				✓	✓				✓				
746-..	Salerno 300 x 150	36/37		▲		✓	✓	✓		▲			●		
747-..	S. mezza 150 x 150	38													
758-..	Novara 190 x 140	39		▲		✓			▲	▲			●	●	●



616-00	Shorty 180/8	56	✓	✓	✓					✓			✓	✓	●
767-00	Easy 180/8	56	✓	✓	✓					✓			✓	✓	●
762-00	Isar 180/8	57	✓	✓	✓					✓			✓	✓	●
740-00	Merkur 200/8	57	✓	✓	✓	✓		✓	✓	✓			✓	✓	●
611-..	Avellino 180 x 130	57		▲		✓		▲	▲				●	●	●
707-..	Napoli 270/6	58		▲		✓	✓	✓		▲	✓		●		
625-..	Bergamo 300/6	58		▲		✓	✓	✓		▲	✓				

- ✓ Possible combination
- ▲ Additional fastening on balcony rail is necessary!
- Additional fastening necessary by umbrella stand or second umbrella holder!

Balcony cross base	Steel balcony umbrella stand ca. 23 kg	Cross stand Standard	Cross stand Plus	PE stand ca. 20 ltr.	PE stand ca. 45 ltr.	PE stand ca. 45 kg	Concrete stand ca. 20 kg	Concrete stand ca. 30 kg	Concrete stand ca. 40 kg	Granite stand ca. 30 kg	Granite stand ca. 42 kg	Trolley granite stand ca. 45 kg
864-00	332-14	837-15	822-15	855-01 white 855-15 anthr.	856-01 white 856-15 anthr.	857-15 anthr.	877-14 silver grey 877-15 anthr.	878-15 anthr.	898-15 anthr.	867-00	869-00	333-00
75	75	76	76	76	76	76	77	77	77	78	78	78

	✓	✓		✓			✓	✓		✓		
●	●	✓				✓		✓	✓	✓		
✓	✓	✓		✓		✓	✓	✓	✓	✓		
●	●	✓						✓	✓	✓		
		✓	✓								✓	✓
		✓	✓								✓	✓

	✓	✓		✓			✓	✓		✓		
	✓	✓		✓			✓	✓		✓		
	●	✓						✓		✓		
	✓	✓		✓			✓	✓		✓		
	✓	✓		✓			✓	✓		✓		
	●	✓						✓		✓		
	✓	✓	✓	✓		✓	✓	✓	✓	✓	✓	✓
	✓	✓	✓	✓		✓	✓	✓	✓	✓	✓	✓
●	●	✓	✓		✓	✓		✓		✓	✓	✓
●	●	✓	✓		✓	✓		✓		✓	✓	✓
●	●	✓	✓		✓	✓		✓		✓	✓	✓
●	●	✓	✓		✓	✓		✓		✓	✓	✓
●	●	✓	✓		✓	✓		✓		✓	✓	✓
●	●	✓	✓		✓	✓		✓		✓	✓	✓
●	●	✓	✓		✓	✓		✓		✓	✓	✓
●	●	✓	✓		✓	✓		✓		✓	✓	✓
●	●	✓	✓		✓	✓		✓		✓	✓	✓
●	●	✓	✓		✓	✓		✓		✓	✓	✓
		✓	✓			✓		✓		✓	✓	✓
		✓	✓			✓		✓		✓	✓	✓
		✓	✓			✓		✓		✓	✓	✓
✓	●	✓	✓		✓	✓		✓		✓	✓	✓
✓						✓			✓			✓
✓	●	✓				✓			✓			✓

	✓	✓		✓			✓					
	✓	✓		✓			✓					
	✓	✓		✓			✓					
	✓	✓		✓			✓	✓		✓		
●	●	✓	✓		✓	✓		✓		✓	✓	✓
●	●	✓	✓			✓		✓		✓	✓	✓

The hanging umbrellas Monaco 3 x 3, Bermuda, Rhodos, Rhodos Smart, Rhodos Junior series, Rhodos Twist series, Rhodos Grande, Rhodos Rondo and Rhodos Blacklight include a light-proof protective sleeve and umbrella stand (slabs not included) and therefore can be used without additional accessories! Additional accessories for hanging umbrellas can be found on page 68 - 71.

Xaver Schneider GmbH & Co. KG · Schirmfabrik

Obereschring 1 · 88512 Mengen · Germany

Phone +49 (0) 7572 7636-0

Telefax +49 (0) 7572 7636-126

info@schneider-schirme.com

www.schneider-schirme.com

www.schneider-werbeschirme.com

Visit us also at:



Website



Online catalogue



All dimensions are approximate!
Subject to colour and size deviations, as well as technical modifications.